

18th November, 2024

To,
National Stock Exchange of India Limited
Exchange Plaza, NSE Building,
Bandra Kurla Complex,
Bandra East, Mumbai-400051

Trading Symbol: SERVOTECH

Sub.: Submission of Investor Presentation made by the Company under Regulation 30 of SEBI (Listing Obligations and Disclosure Requirements) Regulations, 2015

Dear Sir/Madam,

In terms of Regulation 30 of SEBI (Listing Obligations and Disclosure Requirements) Regulations, 2015 and other applicable provisions, please find herewith attached Investor Presentation made by the Company to Investor community meet held today.

Further we wish to inform that the copy of the Investor Presentation is available on the Company website at: www.servotech.in.

This intimation is also being uploaded on the Company's website in compliance with Regulation 46(2) of the Listing Regulations. We request you to take the same on records.

Kindly take the above information on record and oblige.

Thanking You,

FOR SERVOTECH POWER SYSTEMS LIMITED

RUPINDER KAUR
COMPANY SECRETARY AND COMPLIANCE OFFICER
ICSI MEM NO. - A38697

Servotech Power Systems Limited

CIN : L31200DL2004PLC129379

REGISTERED OFFICE : 806, 8th Floor, Crown Heights, Hotel Crown Plaza, Sector-10, Rohini, New Delhi - 110085

PLANT AND R&D : 76A, Sector-57, Kundli Industrial Area, Sonapat, Haryana- 131028

Tel No : 011-41130158, ● Sales : +91 9717691800, ● Email : servotech@servotechindia.com, Website : www.servotech.in

Servotech Power Systems Limited

Company Update
2Q FY2025 , October 2024

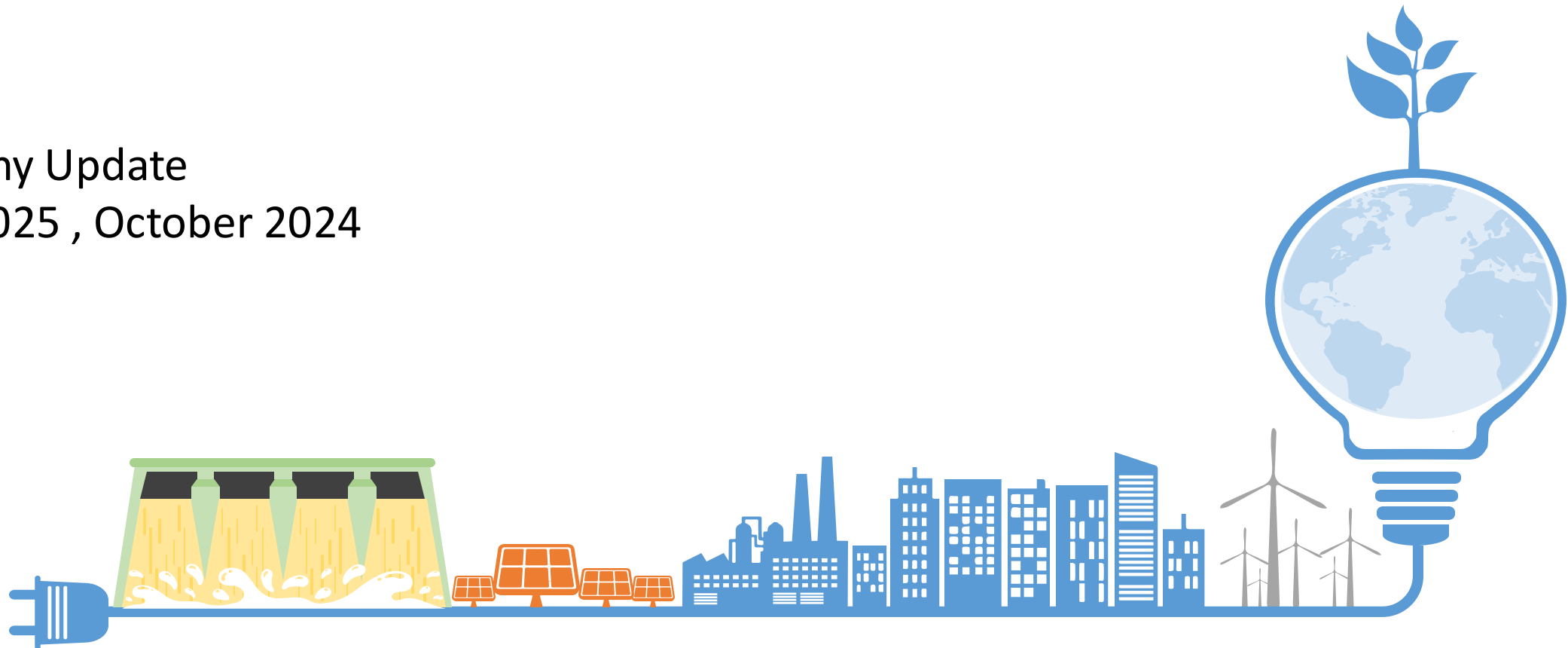

DISCLAIMER

Certain statements in this document may be forward-looking statements. Such forward looking statements are subject to certain risks and uncertainties like government actions, local, political, or economic developments, technological risks, and many other factors that could cause our actual results to differ materially from those contemplated by the relevant forward-looking statements. Servotech Power Systems Limited will not be in any way responsible for any action taken based on such statements and undertakes no obligation to publicly update these forward-looking statements to reflect subsequent events or circumstances.

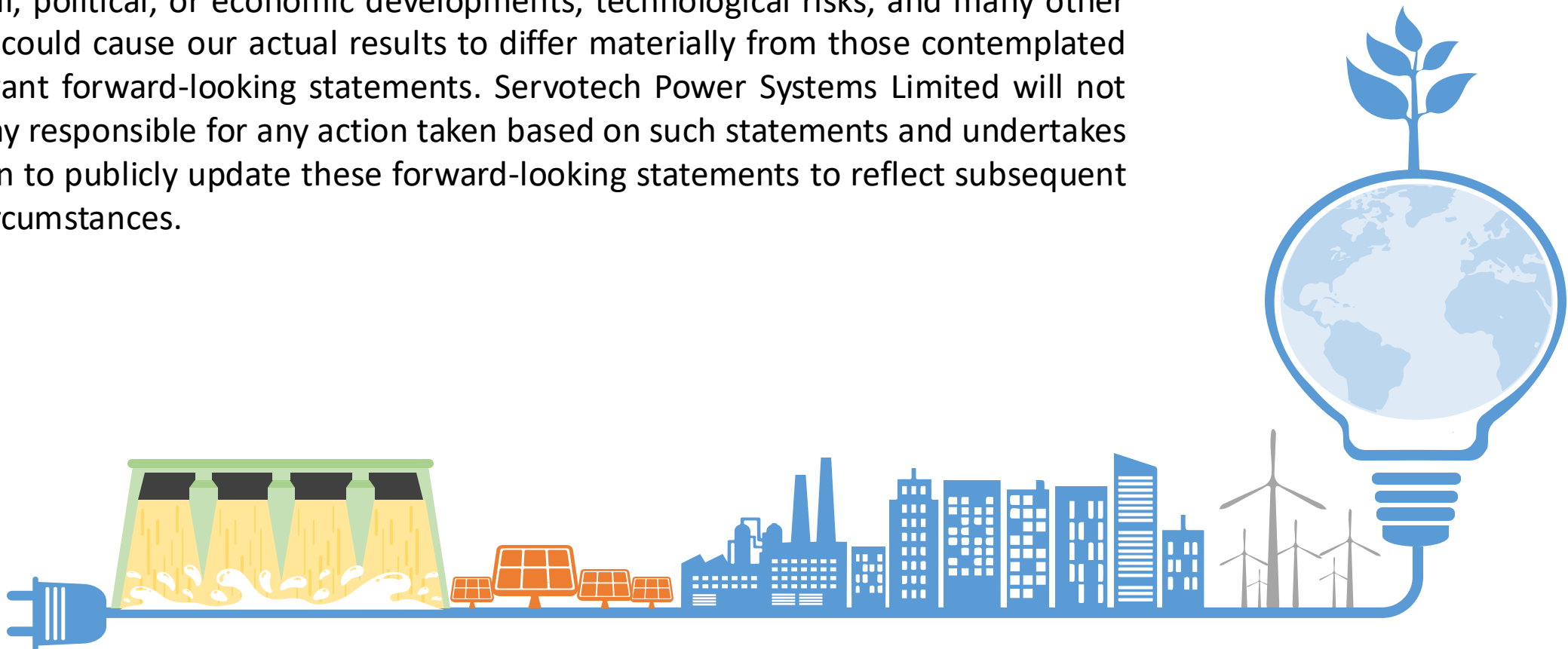

Group Overview

With over two decades of legacy, we are an **NSE-listed company** recognized as one of India's leading manufacturers and sellers of **solar products, EV chargers, LEDs.**

Our robust infrastructure spans over 1,50,000 sq. ft., supported by a skilled workforce and a dedicated team of R&D professionals.

Main Features -

- **Innovative Technology**
- **Sustainability Focus**
- **Tailored Solutions**
- **Customer Centric Approach**
- **Commitment to Quality**

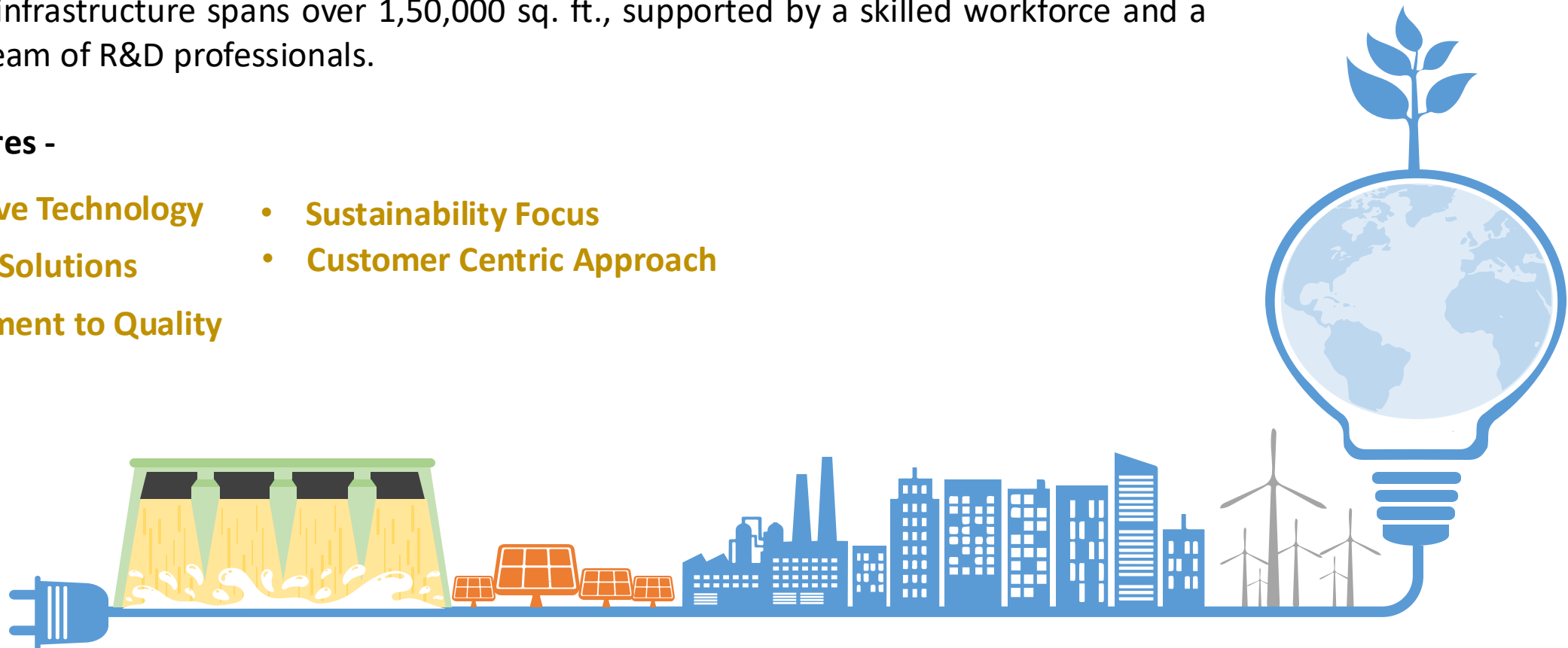

Important Milestones

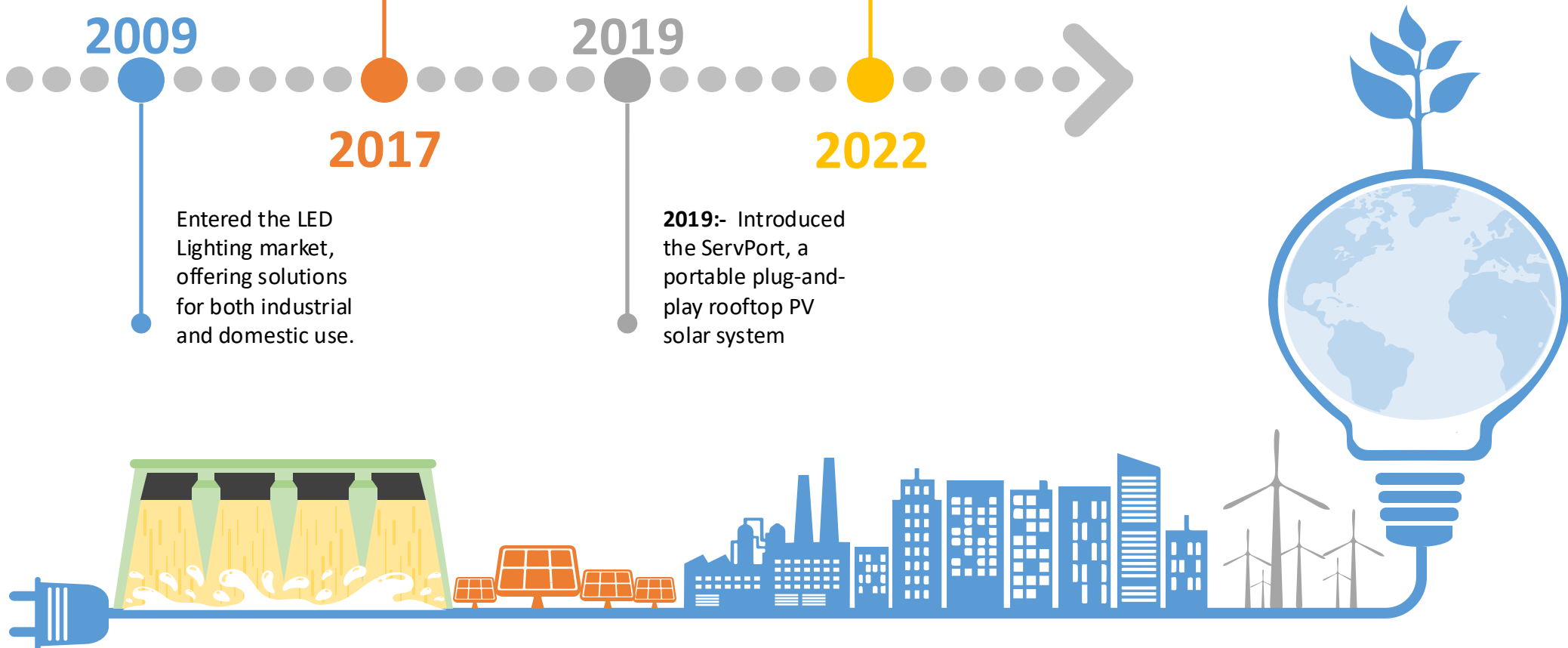
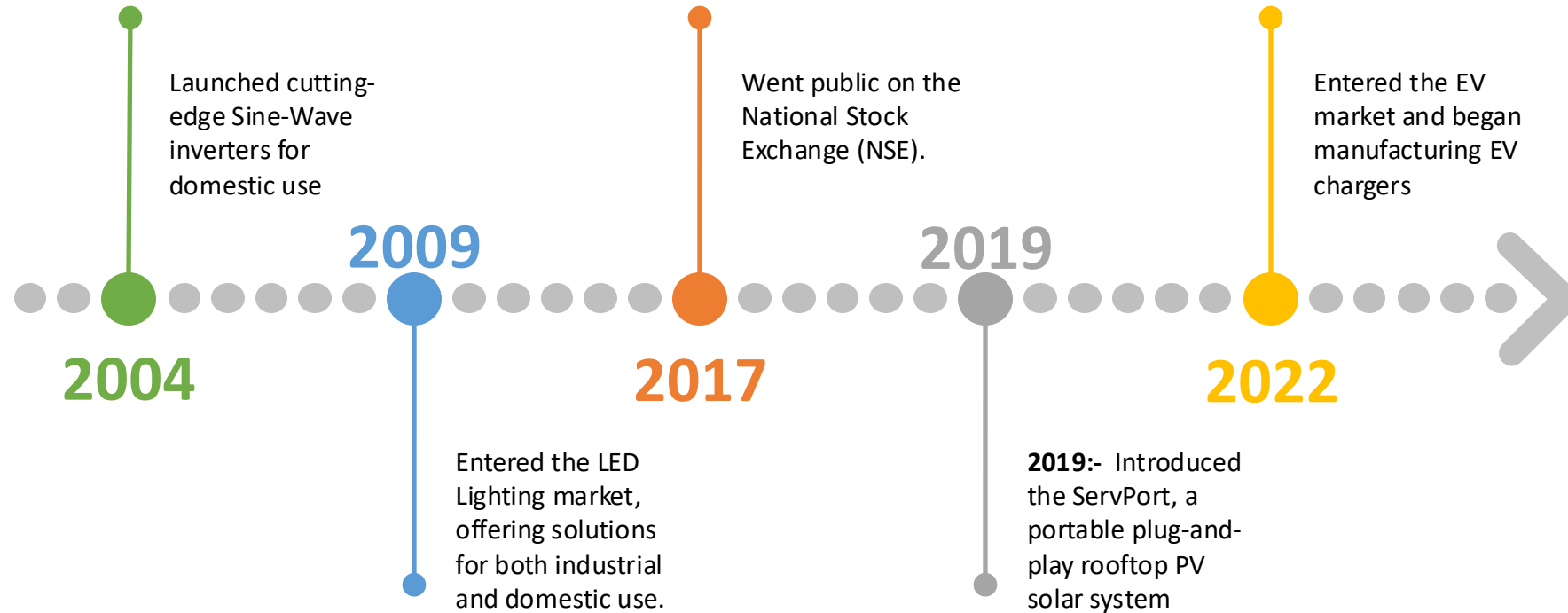

Our Solutions

At Servotech Power Systems, we are more than just a provider of energy solutions—we are your partners in building a sustainable and efficient future. Explore how our innovative products and services can transform your energy management and contribute to a brighter tomorrow.

Solar Products

We offer a wide range of solar energy solutions, including solar panels, inverters, and the groundbreaking Solar ServPort.

EV Chargers

As the electric vehicle (EV) market grows, we offer advanced AC and DC fast charging solutions.

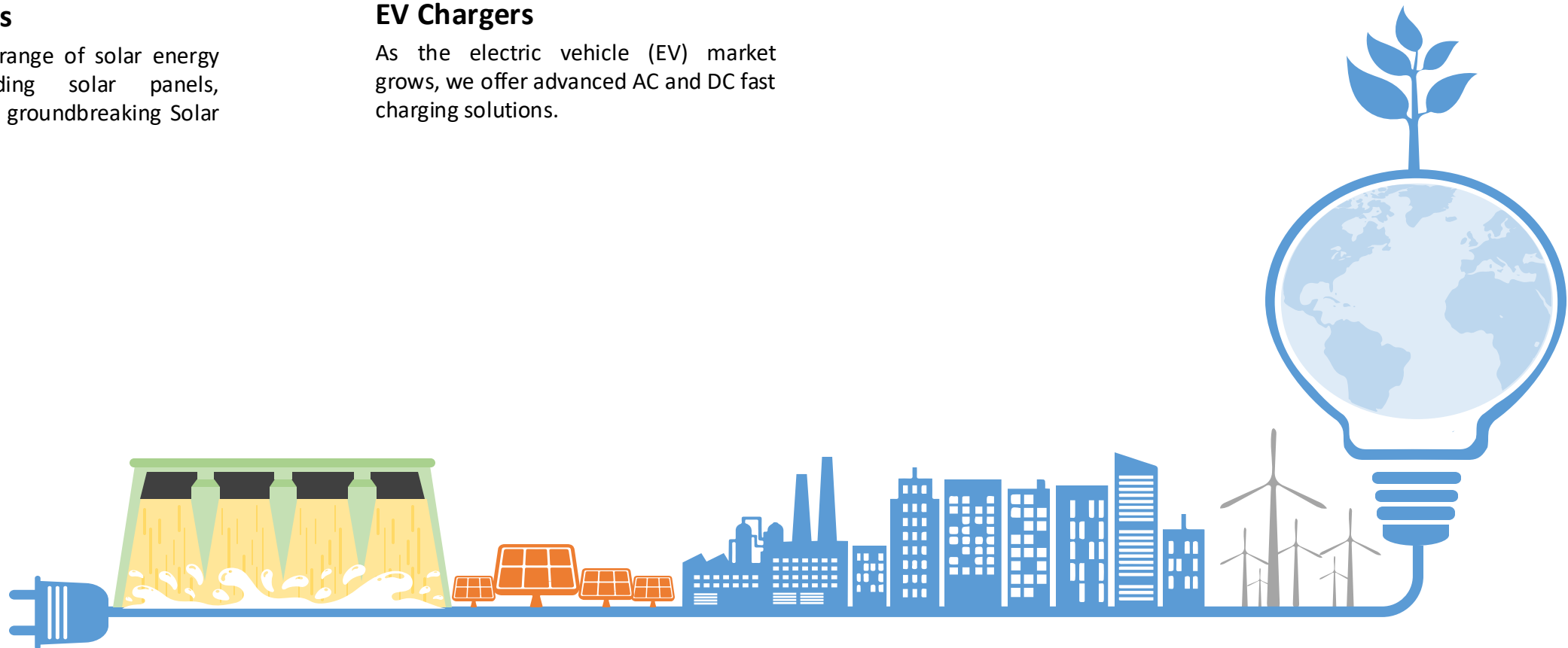

Our Manufacturing Plants



→ Kundli, Sonipat,
Haryana

Safiabad Sonipat,
Haryana ←



Range of Solar Solutions

Solar Panels

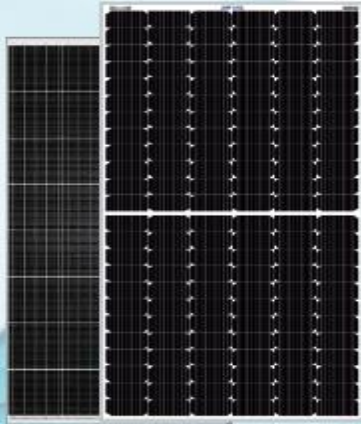

Mono, Perc and Bifacial Panels

Solar Inverters



On-grid, Hybrid and Micro Inverter

Solar Batteries



Tubular and Lithium-ion Battery

Energy Storage System



Solar Pump Controller



Microsync Series Micro Inverter

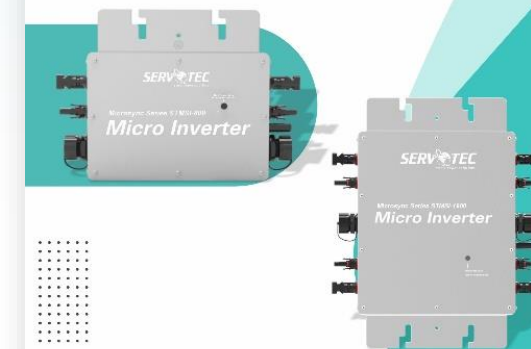

Range of EV Chargers

AC Range



DC Range



Introduction to Servotech's Solar Products



Servlith Series
Energy Storage Systems



Sunfarm Series
VFD-Solar Pump Controller



Solvion Series
On-Grid Solar Inverter



Microsync Series
Micro Inverter

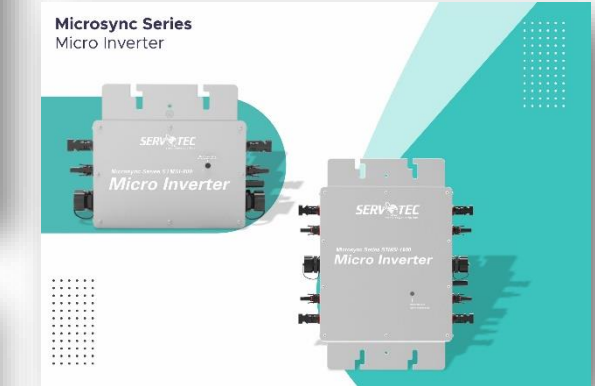

Sparkle Series
Single Phase Hybrid Solar Inverter



Key Clients

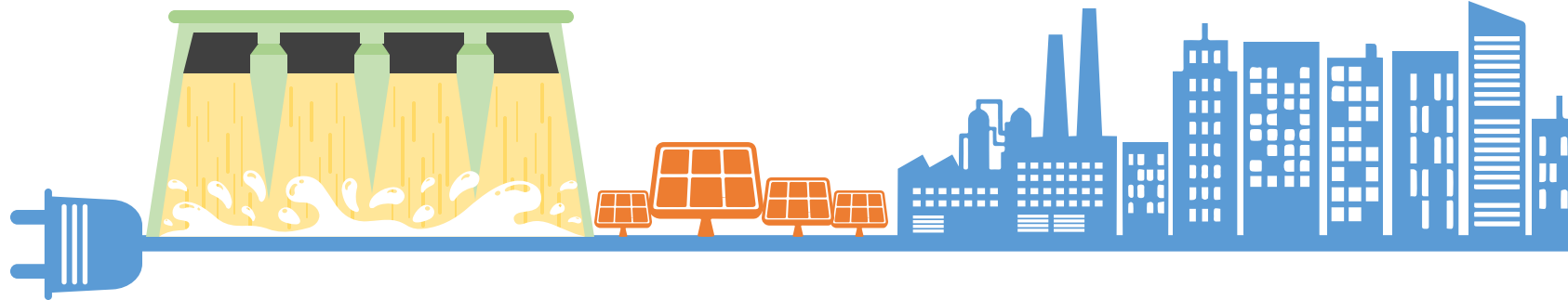

Footprints

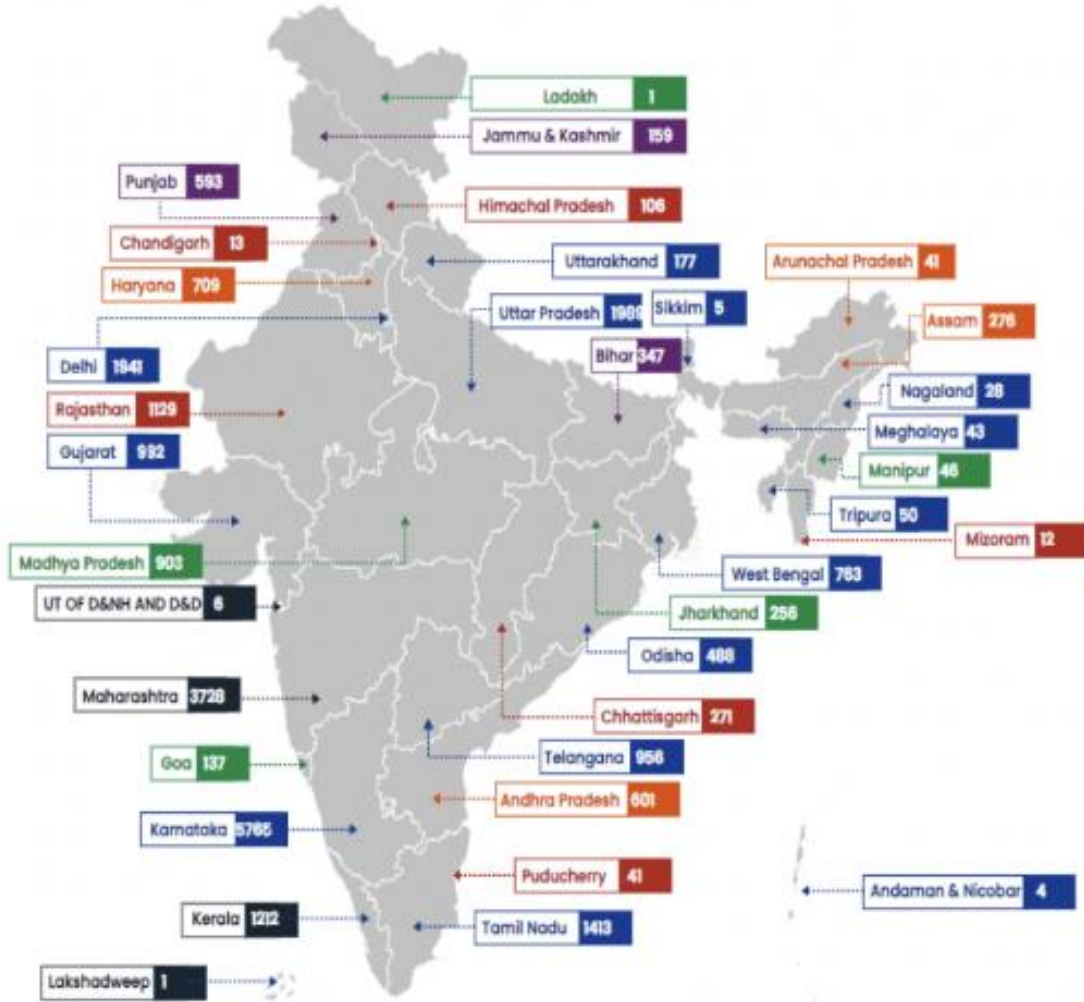

PAN India EV Chargers (all Brands)

7000* EV Chargers /
On 25000 total registered

26% Market Share of registered EV Chargers

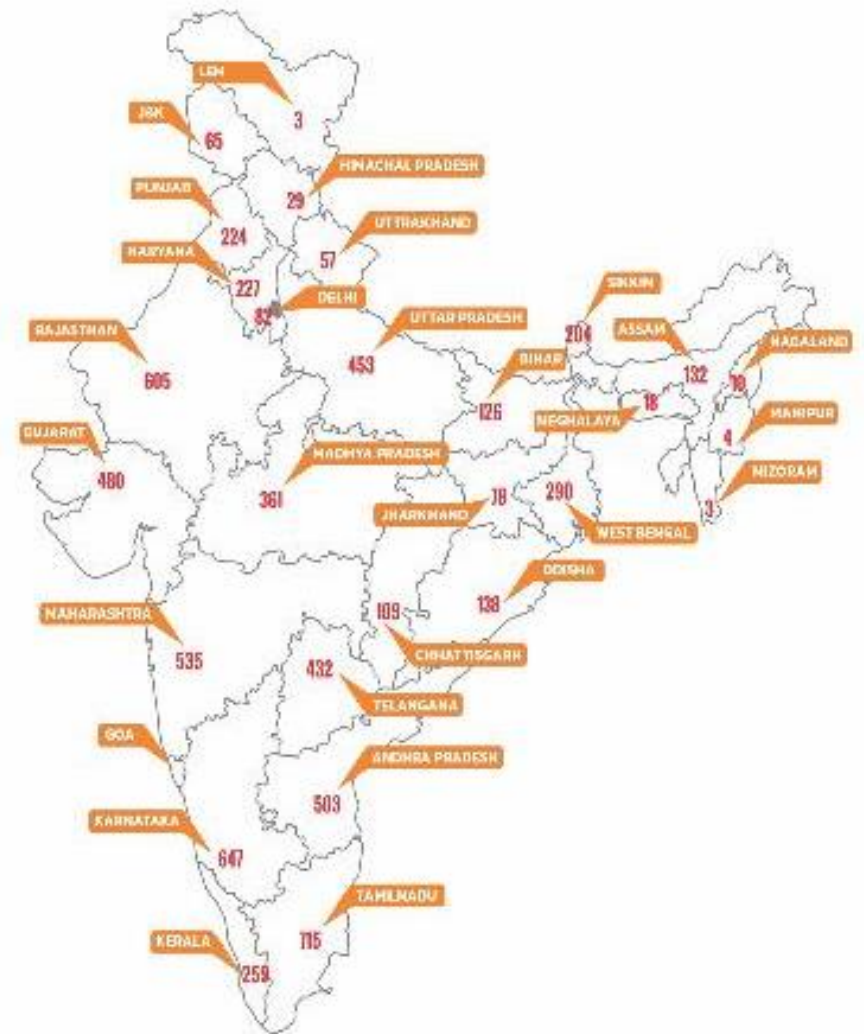

Pan India EV Chargers - Servotech

Revenue Breakup Q2FY25

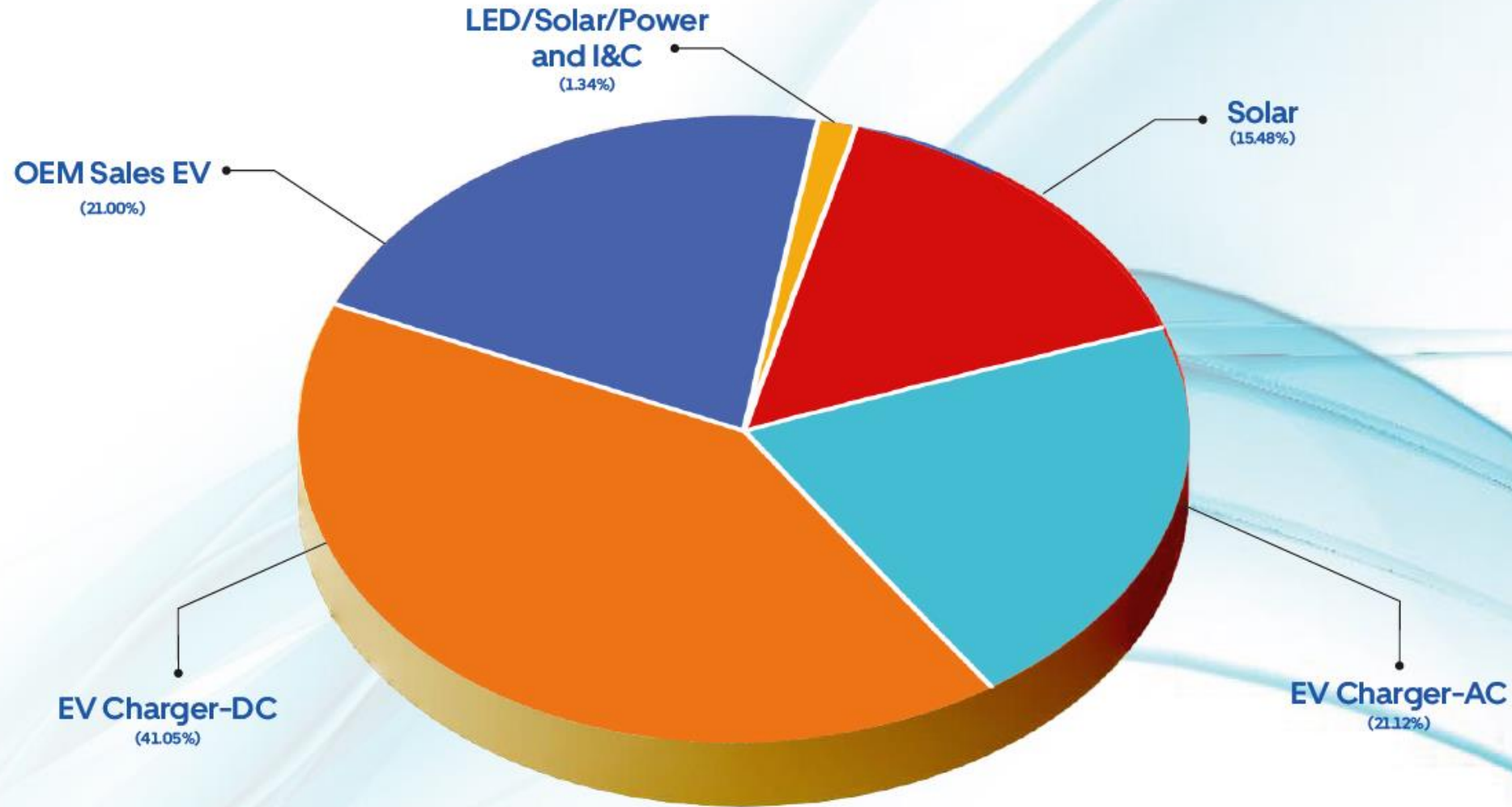

Consolidated Profit & Loss

Growth Trajectory

Particulars (Rs. Lacs)	FY21	FY22	FY23	FY24
Revenue from operations	8,699	14,367	27,848	35,368
Other income	91	58	16	158
Total revenue	8,790	14,425	27,864	35,526
Growth %		64%	93%	27%
Total expenses excluding depreciation, amortization, and finance cost	8,216	13,464	25,969	33,290
EBITDA	575	962	1,895	2,237
EBITDA Margin %	7%	7%	7%	6%
Growth %		67%	97%	18%
Depreciation & Amortization	147	158	213	304
Finance Cost	290	245	238	316
PBT	138	559	1,444	1,617
Tax Expense	23	153	337	436
PAT	115	406	1,106	1,180
PAT Margin %	1%	3%	4%	3%
Growth %		252%	173%	7%

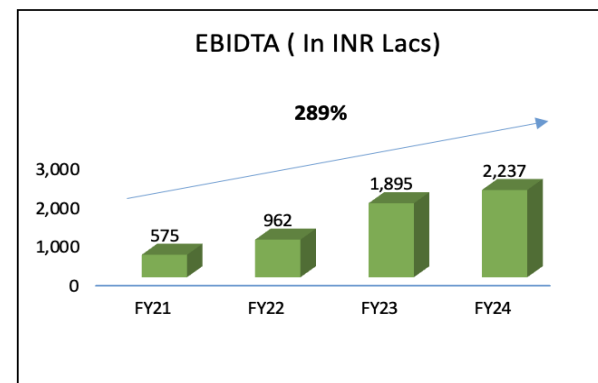
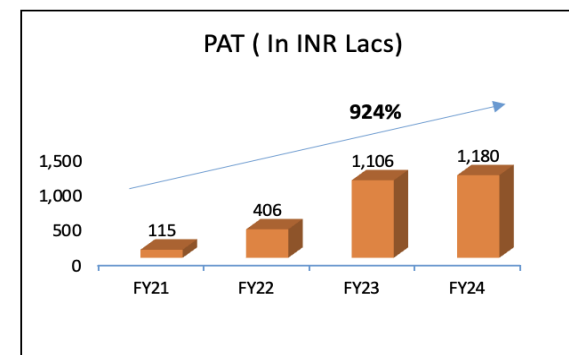
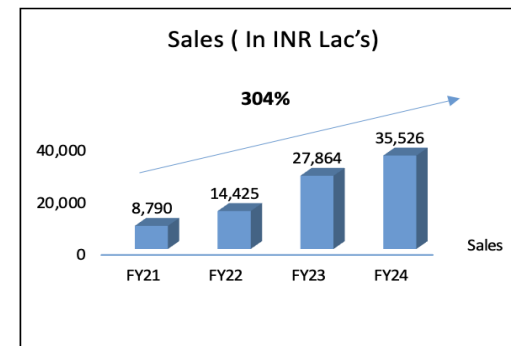

Quarterly Performance

Consolidated Income Statement (Q2: FY25)

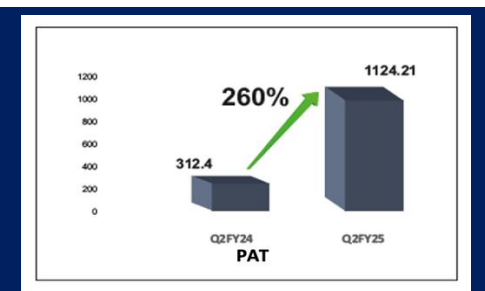
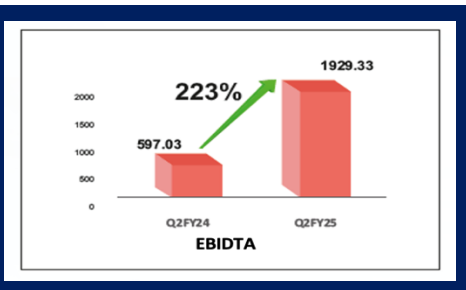
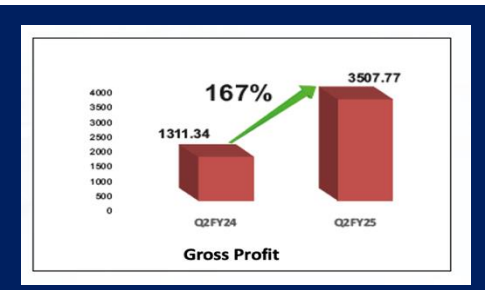
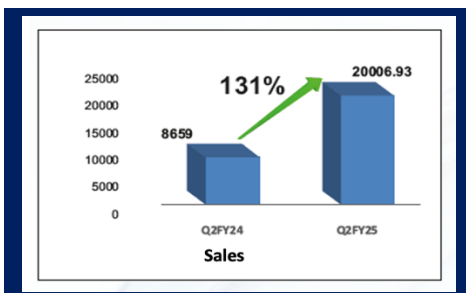

Particulars (Rs. Lacs)	Q2 FY25	Q2 FY24	YoY (%)	H1FY25	H1FY24	YoY%
Revenue from operations	19,967	8,593	132%	31,186	16,550	88%
Other income	40	66		65	91	
Total revenue	20,007	8,659	131%	31,251	16,641	88%
Total expenses excluding depreciation, amortization, and finance cost	18,078	8,062		28,468	15,331	
EBITDA	1,929	597	223%	2,783	1,310	113%
EBITDA Margin %	10%	7%		9%	8%	
Depreciation & Amortization	149	73		245	143	
Finance Cost	248	107		391	200	
PBT	1,532	417		2,147	967	
Tax Expense	409	105		574	243	
PAT	1,123	312	260%	1,573	724	118%
PAT Margin %	6%	4%		5%	4%	
Diluted EPS	0.51	0.15		0.71	0.34	

Price Data (As on 25th October, 2024)	INR
CMP	₹160.17
52 week High/Low	₹205.04/72.75
Market Cap	₹3748.58 Crore
NSE Symbol	SERVOTECH

Share Holding Pattern (as of 30th September, 2024)

Promoter & Promoter Group	59.34%
Institutions	5.96%
Public	34.7%
Total	100.00%

Servotech Price Graph

Sourced from NSE

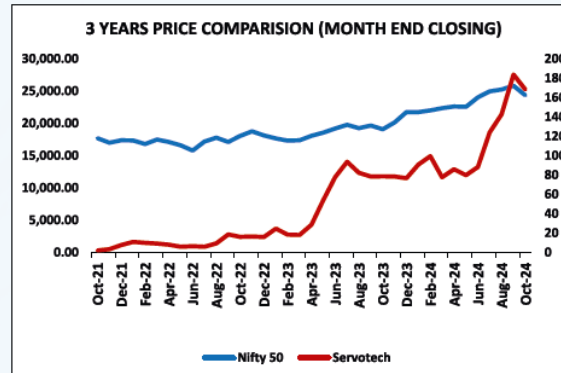

Servotech Growth Drivers

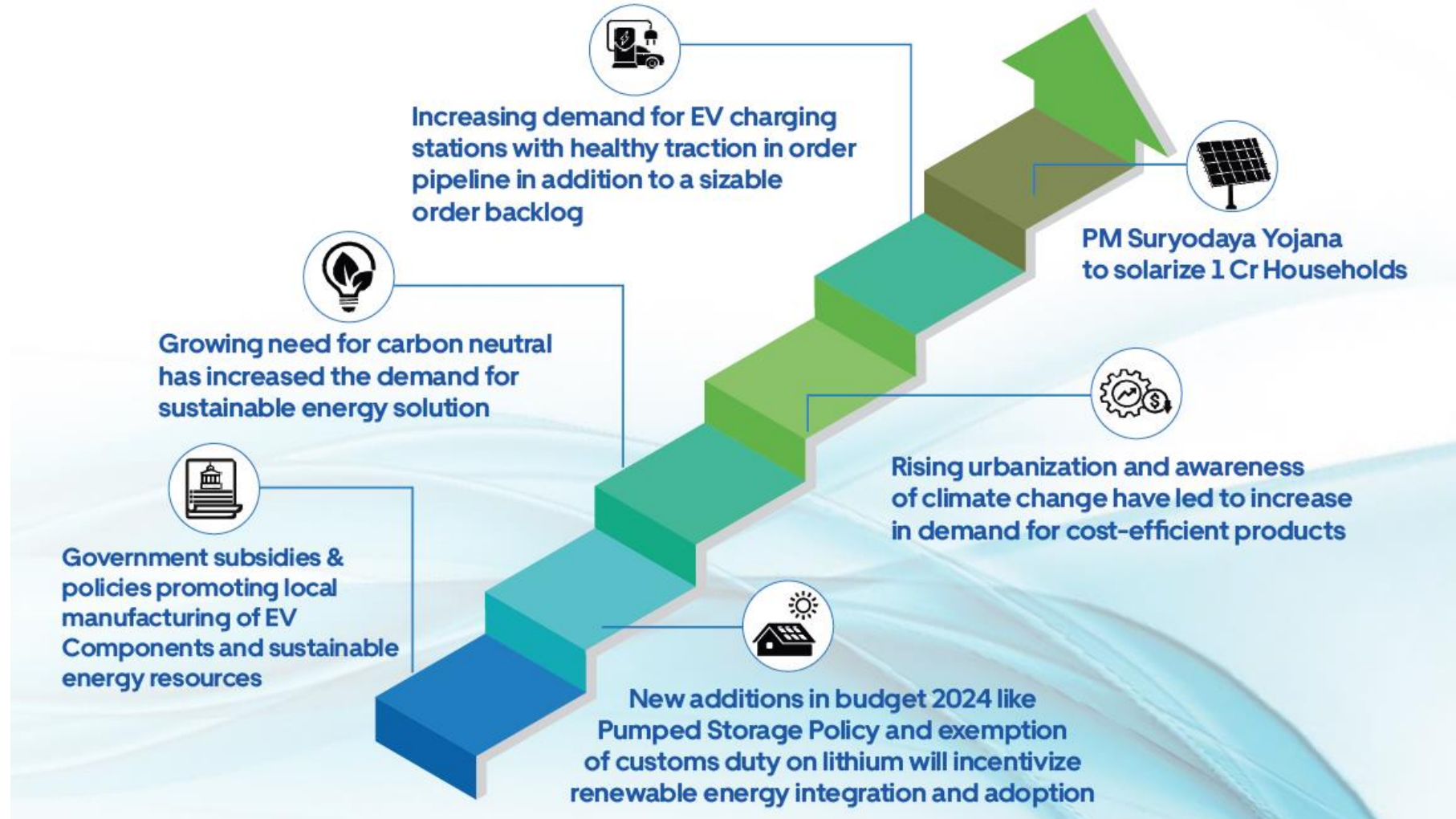

The Future Timelines

Expansion Plan

- Building 12000 unit annual production capacity for Chargers
- To Launch Solar Products & Mobile apps for better customer experience

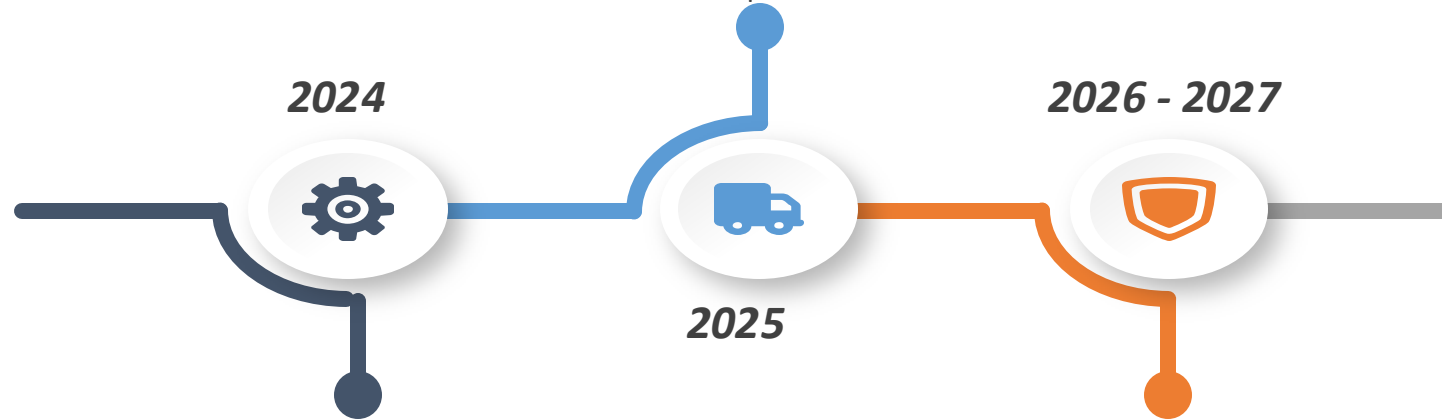

Accomplishments

- Won 60% of the EV charger Business from PSU's from all OMC's
- Entered CPO business through Launch of **Incharz**:
- Started **Servotech Sports and event management** company
- Build SRI Team for **Hydrogen** Domain
- Adopted make in India initiated for **>80% self reliance**

Market Leadership

- Production of Power Module & Control Card PLC
- Entering in OEM Business with the target of catering to majority of Indian OEM Charger Market
- Integrating plan & Technology for **Hydrogen products** aiming footprints in **various countries** across the globe
- Full fledged production for Hydrogen Technology domain with a plan of substantial investment





Thank You

For further information on the company; please visit
www.servotech.in

SERVOTECH POWER SYSTEMS LIMITED

Ms. Rupinder Kaur
Company Secretary
Email: cs@servotechindia.com
Contact: 011-41183116

Ms. POOJA GOEL
Investor Relations
Email: ir@servotechindia.com
Contact: 011-41183116