



# Rane Engine Valve Ltd.

Registered Office:  
" Maithri "  
132, Cathedral Road,  
Chennai 600 086.  
India.  
CIN : L74999TN1972PLC006127

Tel : 044 - 2811 2472  
Fax : 044 - 2811 2449  
URL : www.ranegroup.com

**//Online submission//**

REVL/SE/071/2024-25

February 07, 2025

<b>BSE Limited</b> <b>Listing Centre</b> Scrip Code: <b>532988</b>	<b>National Stock Exchange of India Ltd.</b> <b>NEAPS</b> Symbol: <b>RANEENGINE</b>
--	---

Dear Sir / Madam,

**Sub: Earnings Presentation – Quarterly Unaudited Financial Results for the quarter ended December 31, 2024**

We enclose herewith copy of the Earnings presentation released on the quarterly Unaudited Financial Results for the quarter ended December 31, 2024.

This is also being made available on the Investor Information Section of the website of the Company at the web-link <https://ranegroup.com/investors/rane-engine-valve-limited/>.

We request you to take the above on record and note the compliance with SEBI (Listing Obligations and Disclosure Requirements) Regulations, 2015 (SEBI LODR).

Thanking you,

Yours faithfully,

**For Rane Engine Valve Limited**

**S Anand**  
**Secretary**

Encl: a/a

# **Rane Group**

---

Earnings Presentation | Q3 FY25

# Table of Contents



Q3 FY25 Financial & Operational Performance

Rane Group Overview



# Rane Group

## Q3 FY25 Financial & Operational Performance



To become the Preferred Trusted Supplier of Safety & Critical Auto Components

## Strategic pillars of growth

---

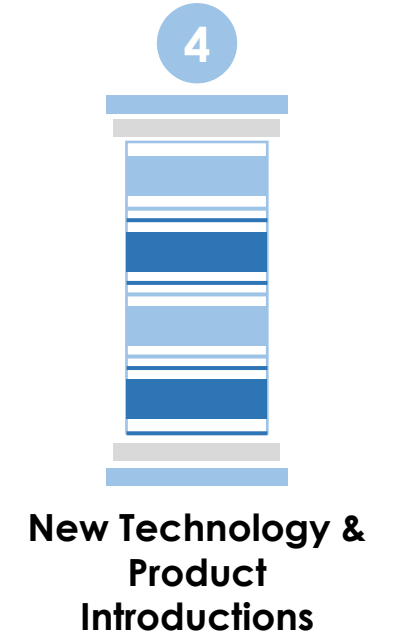
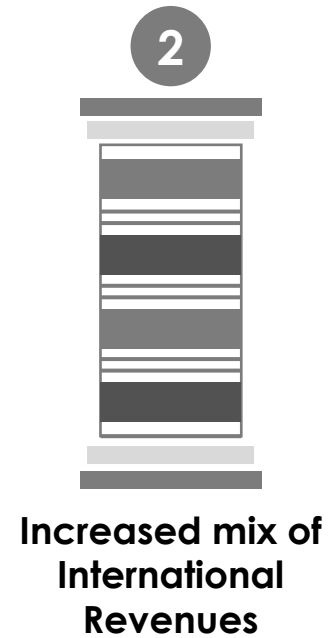

## Business Drivers

- › **92%+ of revenue comes from powertrain agnostic products**
- › **Continued dominance on domestic market across major products**
- › **Increasing export mix for steering & linkages, valve train components and occupant safety products**
- › **Renewed focus on Aftermarket segment leveraging group level synergy**
- › **Continuous new product introductions leveraging strong in-house engineering capabilities**
- › **Increasing efficiencies across manufacturing facilities through operational excellence and digitalization.**

## RANE BRAKE LINING

- Won Rs. 5 Cr order from various customers (incl. Rs. 1.80 Cr from international customers)

## RANE (MADRAS)

- Won orders worth Rs. 43 Cr from domestic customer for Electric LCV application

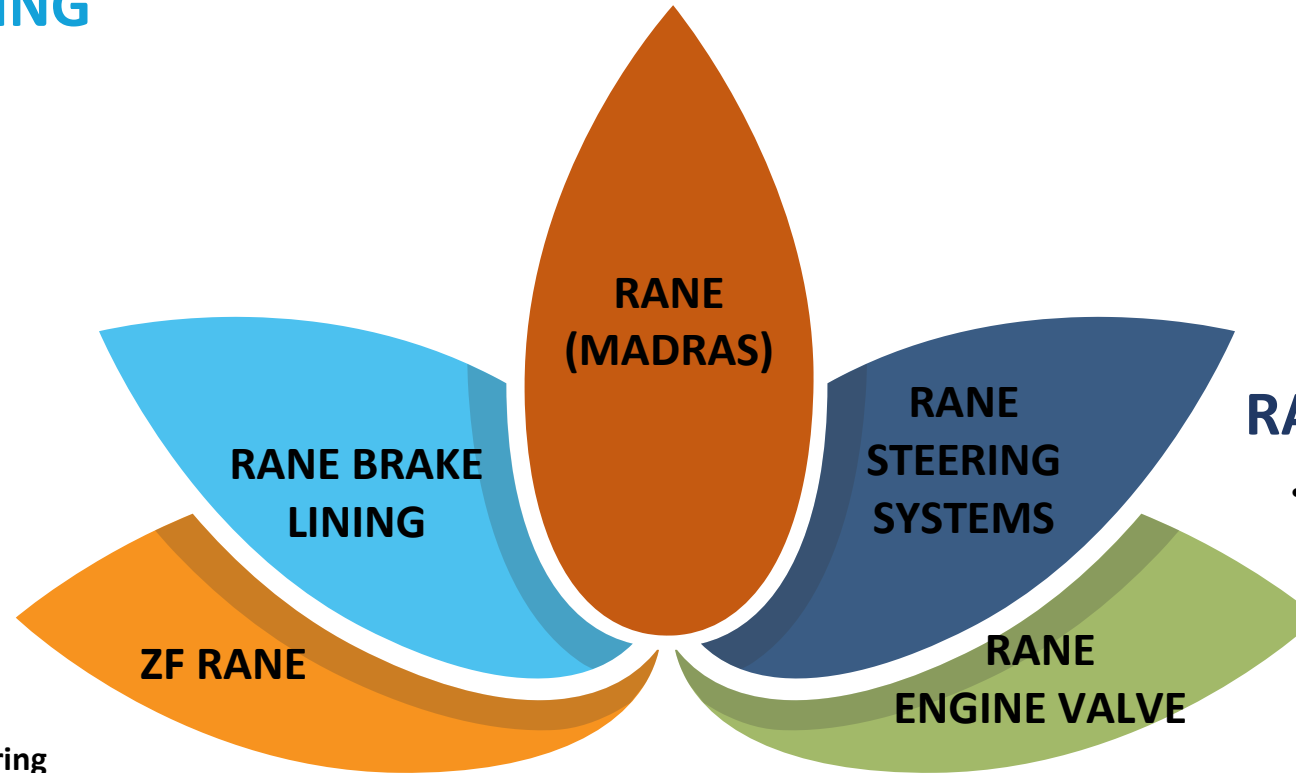

## RANE STEERING SYSTEMS

- Won orders worth Rs. 165 Cr for EPS Steering Column for domestic PV applications

## ZF RANE





- Won orders worth Rs. 7 Cr for steering products from various domestic CV customers for EV application
- Won orders worth Rs. 67 Cr for occupant safety products

## RANE ENGINE VALVE

- Won Rs. 22 Cr order from domestic PV customer

**During the quarter won new business worth about Rs. 310 Cr**

# Group Domestic OE Sales vs. Industry Growth

Industry Performance Review (Q3 FY25)	 Passenger Vehicle	 commercial Vehicle	 Farm Tractor	 2-Wheeler
Production YoY Growth# in %	3%	-3%	12%	8%
Rane Group Sales Growth YoY in % (India OEM)	12%	-14%	0%	1%
Rane Group Revenue Split * (India OEM)	67%	24%	4%	3%
	<ul style="list-style-type: none"> <li>Higher growth than the industry driven by higher growth on served models</li> </ul>	<ul style="list-style-type: none"> <li>Performance is lower than industry due to higher drop in served models</li> </ul>	<ul style="list-style-type: none"> <li>Higher shift to power steering and lower offtake of manual tractors</li> </ul>	<ul style="list-style-type: none"> <li>Lower offtake of valve train components</li> </ul>

\* Other segments such as Rail, Defence, Stationary Engines and 3-Wheeler contributes around 2%

## Market Commentary

- The PV segment had positive momentum and strong performance of the SUV segment
- The MHCV segment continued to face sluggish demand, attributed to low infrastructure spending
- The growth in the FT segment is supported by improved rural sentiment and above-normal rainfall
- The 2W segment sustained the upward trajectory, fueled by robust domestic sales and strong demand from export markets



# Group Aggregate Sales (Q3 FY25)

## Group Aggregate Sales (Rs cr.)

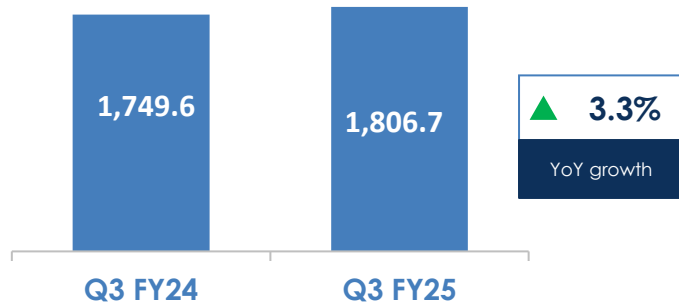

- › Sales increased by 3.3% from Rs. 1,749.6 Cr in Q3 FY24 to Rs. 1,806.7 Cr in Q3 FY25
- Revenue from Indian OE customers grew by 3% on account of higher offtake from passenger vehicle segment.
- Revenues from International customers decreased by 1% due to slight drop in sales of occupant safety products
- Revenue from Indian aftermarket segment increased by 14% supported by higher demand for steering and friction products

## Group Aggregate Sales (Q3 FY25)

### BY PRODUCT (%)

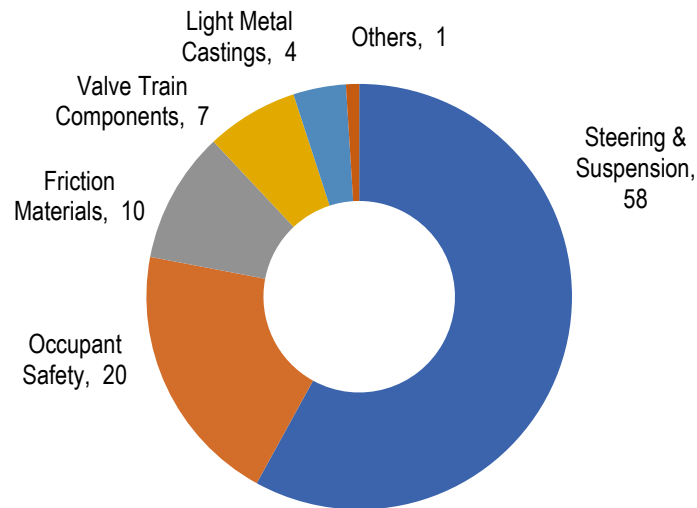

### BY MARKET (%)

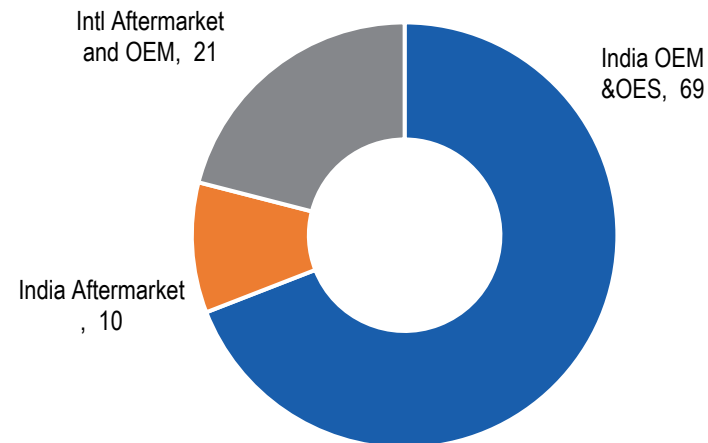

### BY VEHICLE SEGMENT (%)

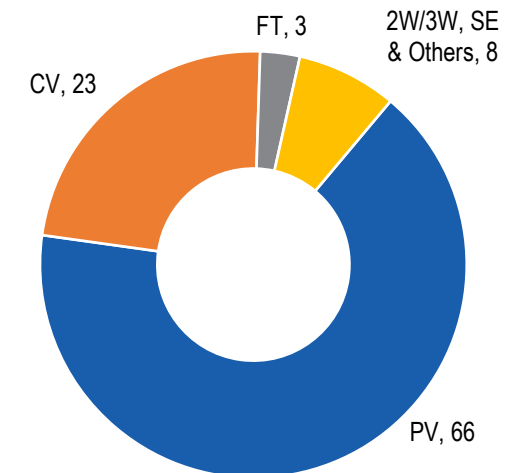

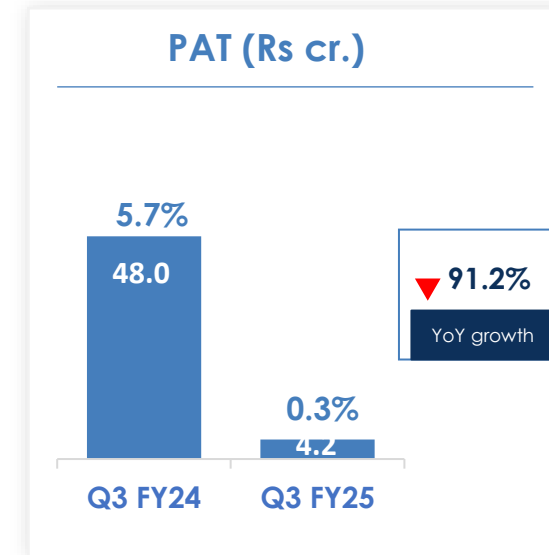
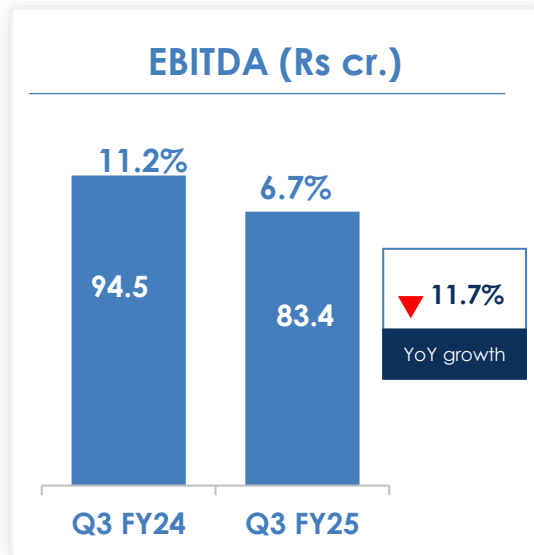
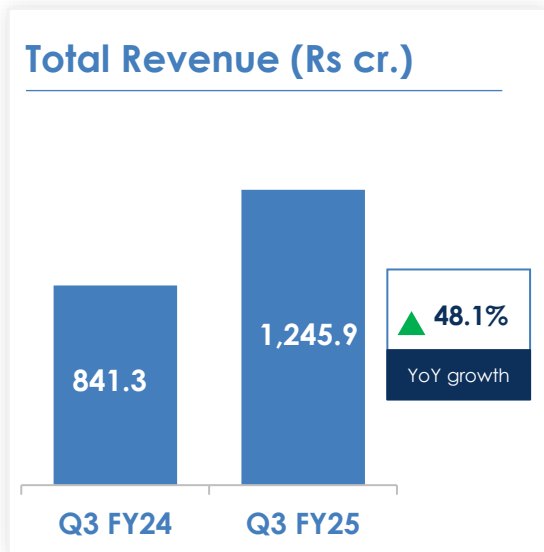

› **Total Revenue increased by 48.1% from Rs. 841.3 Cr in Q3 FY24 to Rs. 1,245.9 Cr in Q3 FY25**

- Consolidated sales grew by 48% mainly because of RSSL becoming a wholly owned Subsidiary.
- On like-for-like basis, sales grew by 1%. Lower offtake from Indian OE customers was partially offset by marginal growth in sales to international customers. Sales to Aftermarket customers grew by 13%.

› **EBITDA decreased by 11.7% from Rs. 94.5 Cr in Q3 FY24 to Rs. 83.4 Cr in Q3 FY25**

- EBITDA margin decreased 453 bps This was due to consolidation of RSSL which had an adverse product mix. In addition, there was a one-off provision for obsolete inventory, premium freight and forex reinstatement loss on overseas investments held by RML. There was also a one-off provision reversal in employee cost in Q3 FY24.

› **PAT decreased by 91.2% from Rs.48 Cr in Q3 FY24 to Rs. 4.2 Cr in Q3 FY25**

- One-time impact of Rs. 10.5 Cr on account of tax credit reversal due to adoption of New Income Tax Regime by REVL.

# **Rane (Madras) Limited**

## **Q3 FY25 Financial & Operational Performance**

## Business Drivers

- › Challenging demand environment in India due to decline in the commercial vehicle and higher migration to power steering in the farm segment
- › Despite drop in ATV segment, continued to see positive momentum in the exports from other vehicle segments

## Operational Highlights

- › Received CII Regional Award for Excellence in Water Management

## Business Split (Q3 FY25) – RML India

### BY MARKET (%)

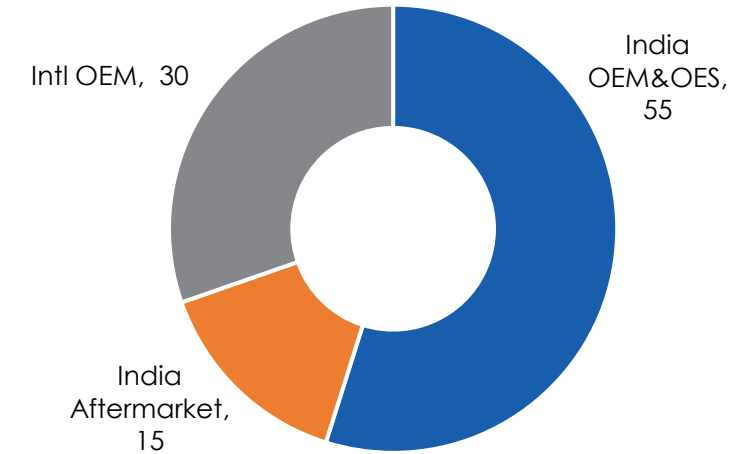

### BY VEHICLE SEGMENT (%)

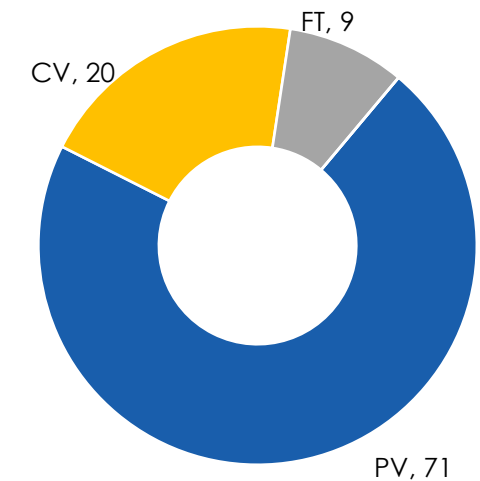

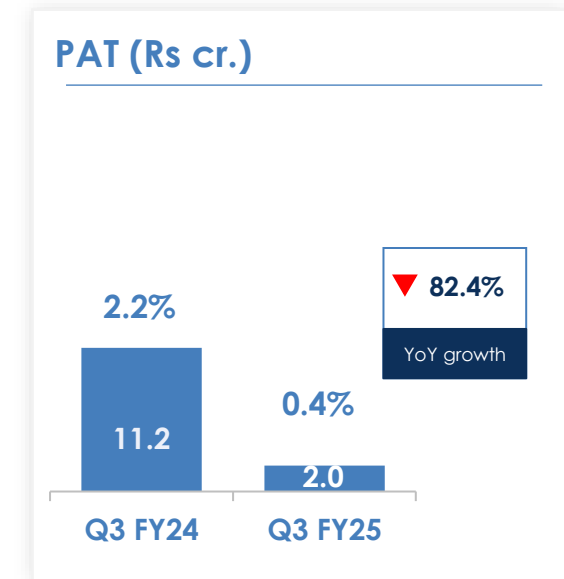
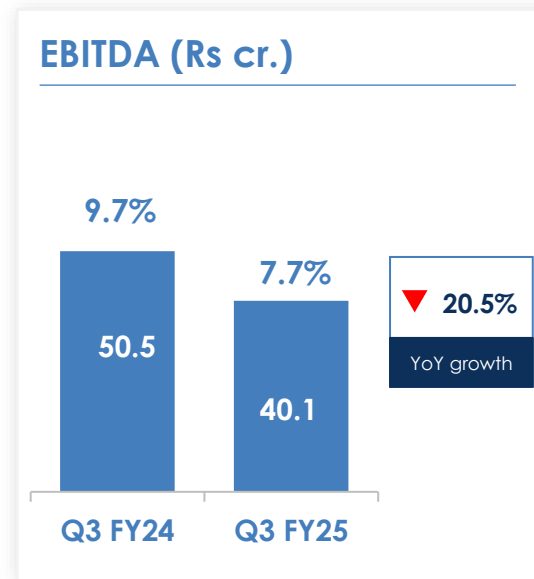
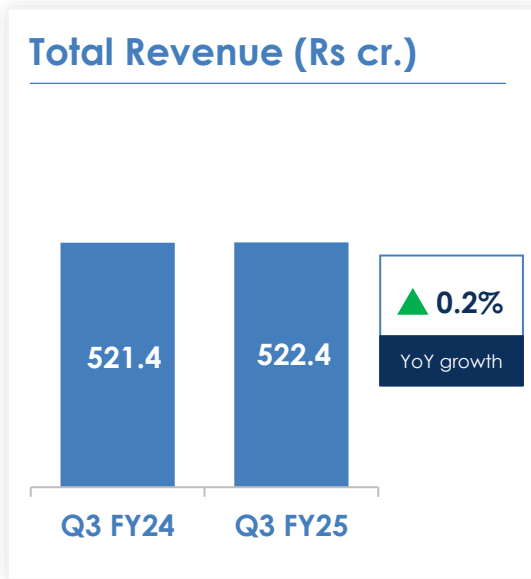

› **Total Revenue increased by 0.2% from Rs. 521.4 Cr in Q3 FY24 to Rs. 522.4 Cr in Q3 FY25**

- Sales to Indian OE customers declined by 4%. Lower offtake from CV and FT segments.
- Export sales grew 2%.
- Sales to Indian Aftermarket customers increased by 14%.

› **EBITDA decreased by 20.5% from Rs. 50.5 Cr in Q3 FY24 to Rs. 40.1 Cr in Q3 FY25**

- EBITDA margin declined by 200 bps due to one off provision for obsolete inventory, premium freight and forex reinstatement loss on overseas investments. There was also a one-off provision reversal in employee cost in Q3 FY24

› **PAT decreased by 82.4% from Rs. 11.2 Cr in Q3 FY24 to Rs. 2.0 Cr in Q3 FY25**

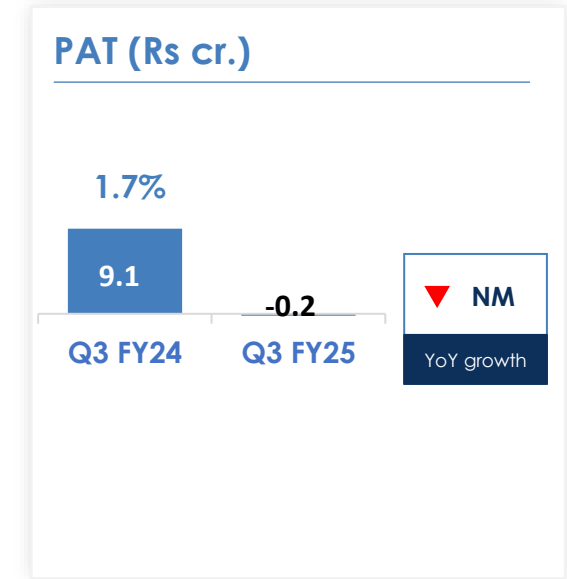
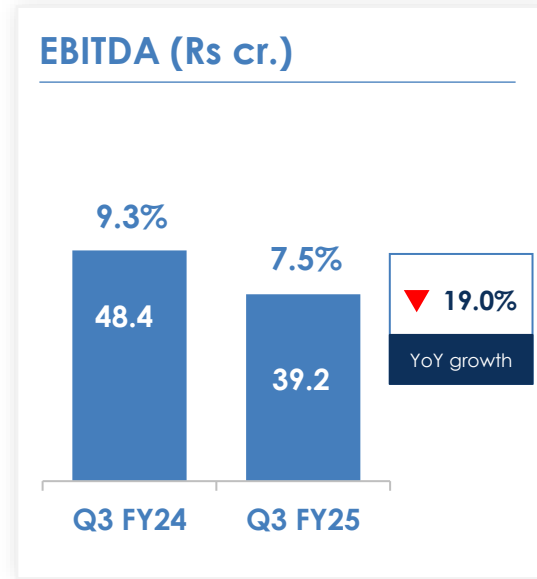
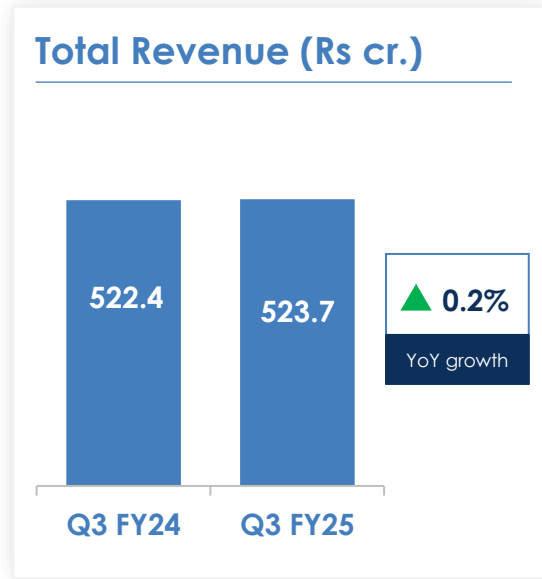

- › Total Revenue increased by 0.2% from Rs. 522.4 Cr in Q3 FY24 to Rs. 523.7 Cr in Q3 FY25
- › EBITDA decreased by 19.0% from Rs. 48.4 Cr in Q3 FY24 to Rs. 39.2 Cr in Q3 FY25
- › Net loss of Rs. 0.2 Cr for Q3 FY'25 compared to PAT of Rs. 9.1 Cr for Q3 FY'24



# **Rane Engine Valve Limited**

## **Q3 FY25 Financial & Operational Performance**



## Business Drivers

- › 41% of revenue generated from EV insulated segment
- › Sustained financial improvement

## Operational Highlights

- › REVL has won TPM significant Achievement Award from CII for scaling Excellence and Agility for Business Transformation
- › All plants showed improvement in the average production per day

### Business Split (Q3 FY25)

#### BY MARKET (%)

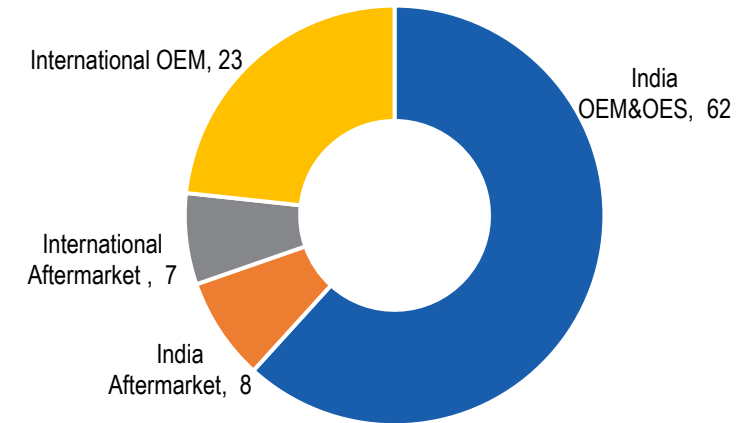

#### BY VEHICLE SEGMENT (%)

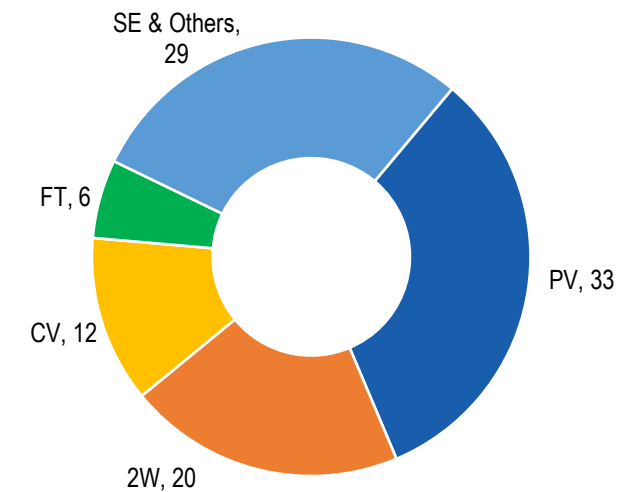



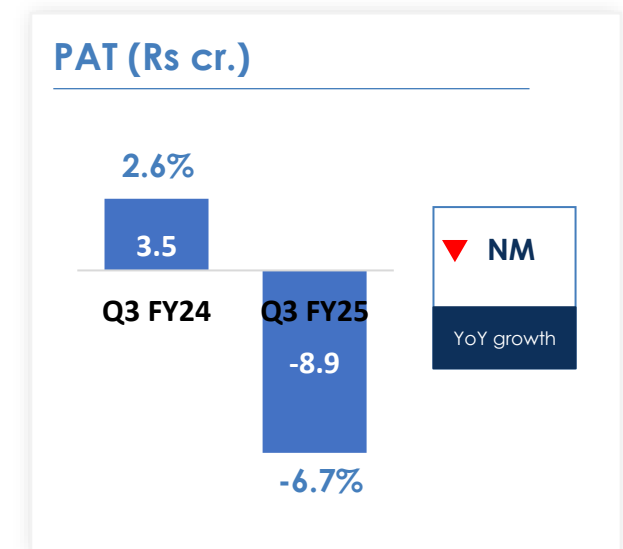
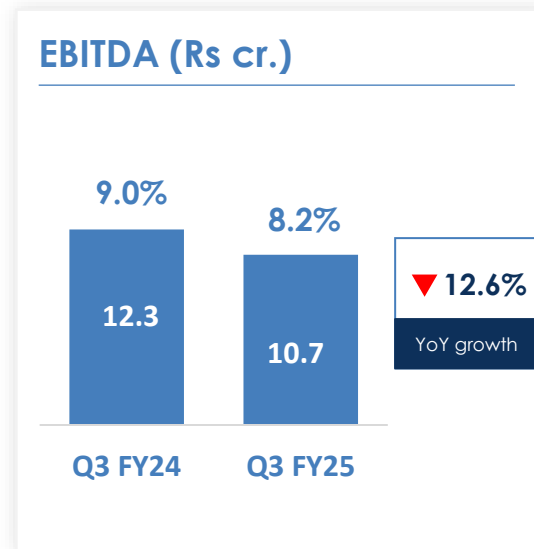
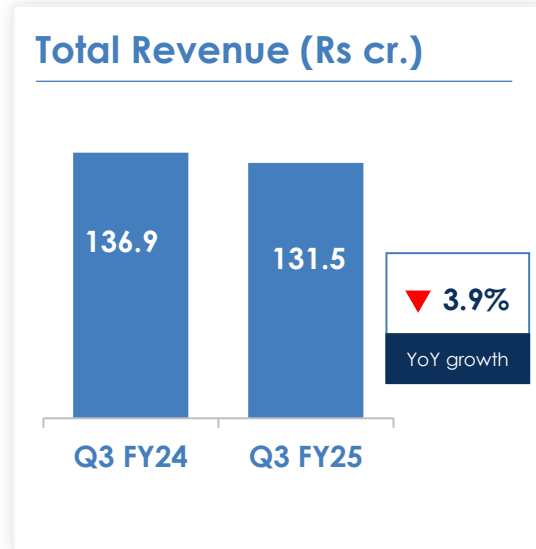

› **Total Revenue decreased by 3.9% from Rs. 136.9 Cr in Q3 FY24 to Rs. 131.5 Cr in Q3 FY25**

- Sales to India OE customers declined by 2% mainly due to drop in commercial vehicle and stationary equipment segment.
- Export Sales declined by 8%. Offtake from International OE customers remained favourable however this was offset by drop in the aftermarket customers.
- Sales to Indian Aftermarket customers grew by 1%.

› **EBITDA decreased by 12.6% from Rs. 12.3 Cr in Q3 FY24 to Rs. 10.7 Cr in Q3 FY25**

- Better product mix and favourable forex was offset due to one-off provision reversal on employee cost in Q3 FY24 resulting in lower EBITDA margin

› **Net loss of Rs. 8.9 Cr in Q3 FY25 compared to PAT of Rs. 3.5 Cr in Q3 FY24**

- One-time impact of Rs. 10.5 Cr on account of tax credit reversal due to adoption of New Income Tax Regime.



# **Rane Brake Lining Limited**

## **Q3 FY25 Financial & Operational Performance**



## Business Drivers

- › Market leader in Passenger Vehicle and Two Wheeler segment.
- › Strong presence in Indian Aftermarket segment.
- › Expanding presence in the International Aftermarket segment

## Operational Highlights

- › Trichy Plant received GreenCo - Gold rating from CII

**Business Split (Q2 FY25)**  
**BY MARKET (%)**

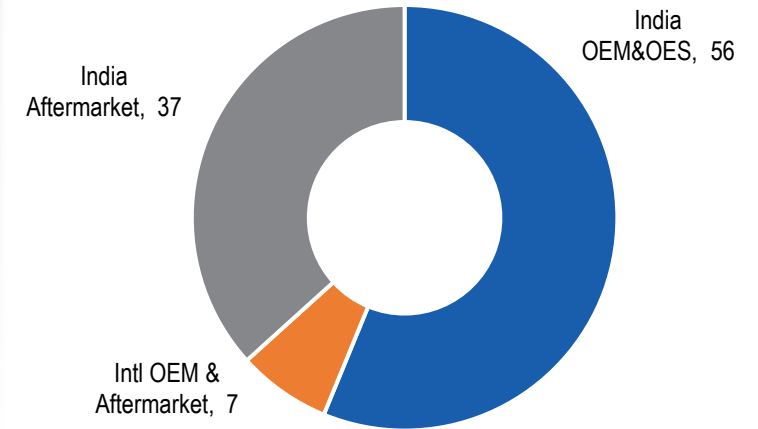

**BY VEHICLE SEGMENT (%)**

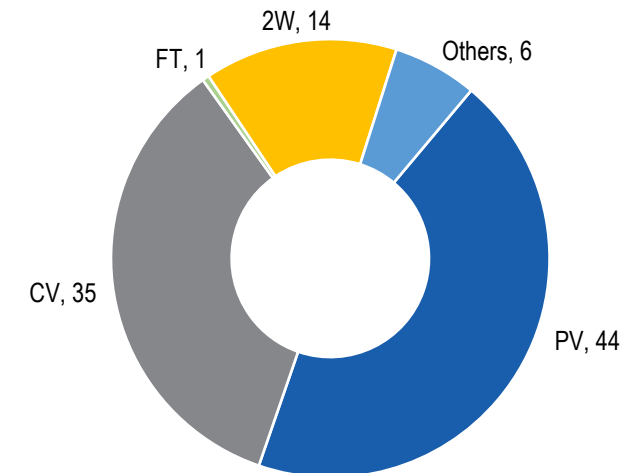

## Total Revenue (Rs cr.)

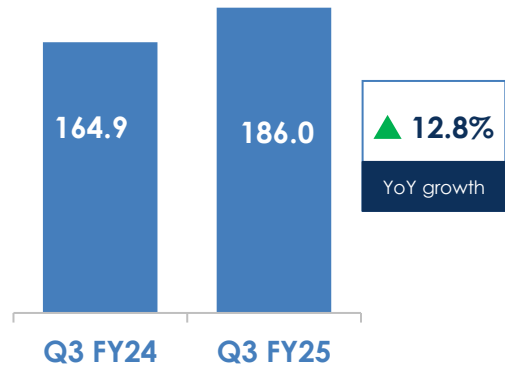

## EBITDA (Rs cr.)

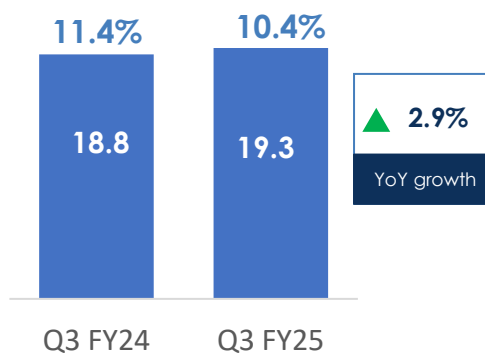

## PAT (Rs cr.)

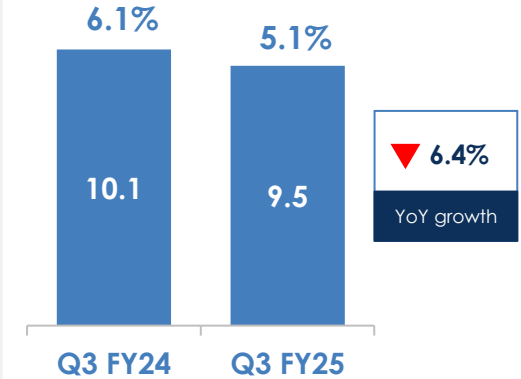

› **Total Revenue increased by 12.8% from Rs. 164.9 Cr in Q3 FY24 to Rs. 186.0 Cr in Q3 FY25**

- Sales to OE customer grew 8%. Strong growth driven by demand from passenger vehicle and two wheeler segments.
- Sales to Aftermarket customers grew 15%.
- Export sales grew 51%. Strong orders from US and other served regions.

› **EBITDA increased by 2.9% from Rs. 18.8 Cr in Q3 FY24 to Rs. 19.3 Cr in Q3 FY25**

- EBITDA margin declined by 100 bps. Favourable product mix and forex was offset by increase in employee cost and one-off provisions

› **PAT decreased by 6.4% from Rs. 10.1 Cr in Q3 FY24 to Rs. 9.5 Cr in Q3 FY25**

# **Rane Steering Systems Private Limited**

**(formerly known as Rane NSK Steering Systems Private Limited)**

## **Q3 FY25 Financial & Operational Performance**

## Business Drivers

- › Drop in passenger car segment was offset by higher volume of SUV segment
- › Lower commercial vehicle volume impacted Manual Steering Column product

## Operational Highlights

- › Won “Outstanding Contribution in Supply Chain Management” under the Proprietary Category award from Volvo Eicher Commercial Vehicles Ltd.

### Business Split (Q3 FY25)

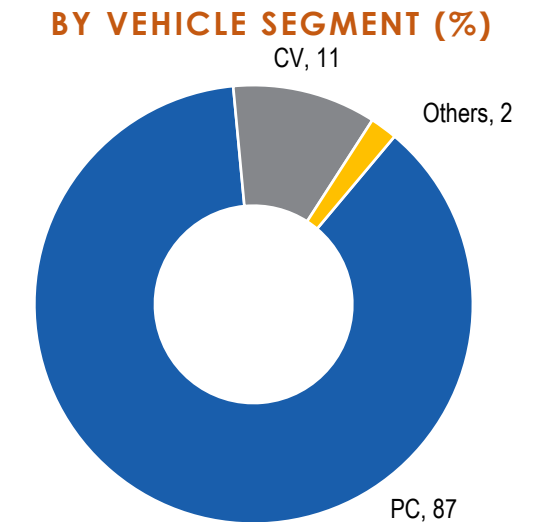
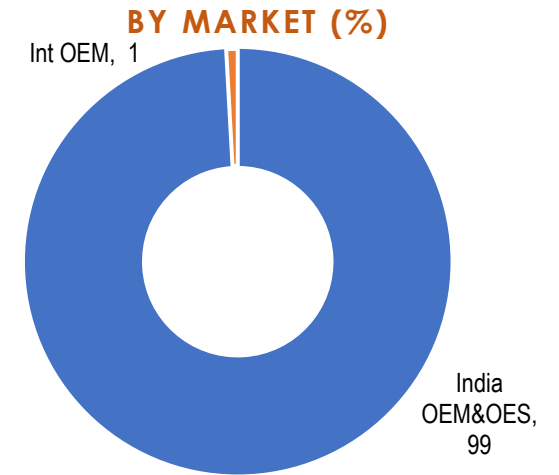

## Total Revenue (Rs cr.)

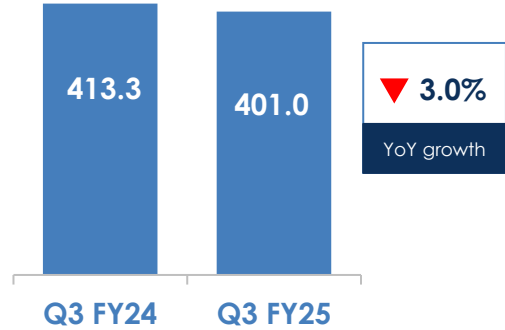

## EBITDA (Rs cr.)

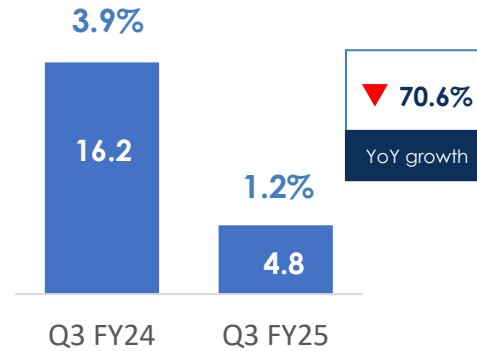

## PAT (Rs cr.)

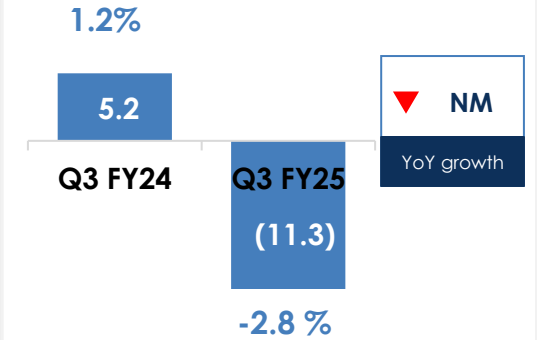

- › **Total Revenue decreased by 3.0% from Rs. 413.3 Cr in Q3 FY24 to Rs. 401.0 Cr in Q3 FY25**
- Drop in commercial vehicle segment resulted in marginal decline of the sales
- › **EBITDA decreased by 70.6% from Rs. 16.2 Cr in Q3 FY24 to Rs. 4.8 Cr in Q3 FY25**
- Adverse product mix impacted the profitability
- › **Net loss of Rs. 11.3 Cr for Q3 FY25 compared to PAT of Rs. 5.2 Cr in Q3 FY24**



# **ZF Rane Automotive India Private Limited**

## **Q3 FY25 Financial & Operational Performance**



## Business Drivers

- › Drop in commercial vehicle segment impacted steering division
- › Occupant safety division benefited from increased preference for safer cars

## Operational Highlights

- › ZRAI SGD won an award for achieving Q-Prime certification from Daimler India Commercial Vehicles in recognition of its end-to-end quality excellence

### Business Split (Q3 FY25)

#### BY MARKET (%)

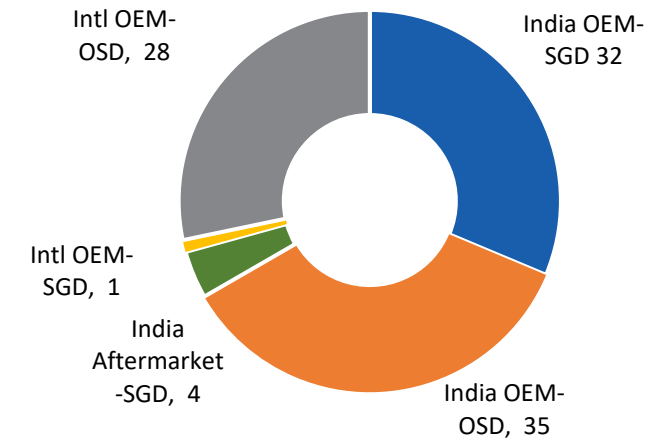

#### BY VEHICLE SEGMENT (%)

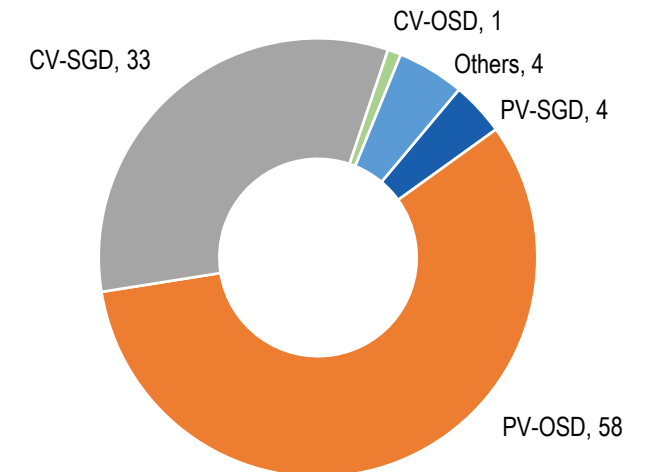

## Total Revenue (Rs cr.)



## EBITDA (Rs cr.)



## PAT (Rs cr.)



› **Total Revenue increased by 9.2% from Rs. 549.8 Cr in Q3 FY24 to Rs. 600.5 Cr in Q3 FY25**

- Revenue from steering products declined 14% due to drop in Commercial Vehicle segment
- Revenue from occupant safety systems grew 15% supported by higher offtake in domestic customers

› **EBITDA increased by 8.8% from Rs. 57.7 Cr in Q3 FY24 to Rs. 62.8 Cr in Q3 FY25**

- EBITDA margin remained steady at 10.5%. Favourable material cost was offset due to one-off provision reversal on employee cost in Q3 FY24

› **PAT decreased by 29.6% from Rs. 24.8 Cr in Q3 FY24 to Rs. 17.5 Cr in Q3 FY25**



# Rane Group

## About Us



Founded in 1929 and headquartered in Chennai, Rane Group is one of the preferred OE manufacturer and supplier for global auto majors



The Group serves a variety of industry segments: Passenger Vehicles, Commercial Vehicles, Farm Tractors, Two-wheelers, Three-wheelers, Railways and Stationary Engines



Manufactures Steering and Suspension systems, Friction materials, Valve train components, Occupant safety systems and Light metal casting products.

REVENUE BY MARKET (%)

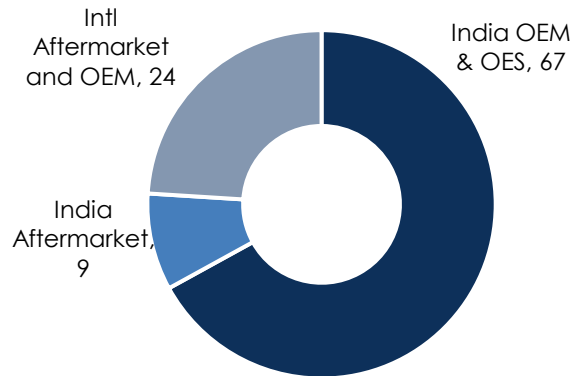

REVENUE BY VEHICLE SEGMENT (%)

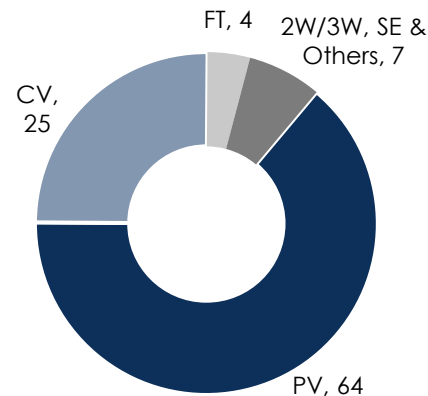

## GROUP SALES OF INR 7,199 CR (~USD 870 MN)-FY'24

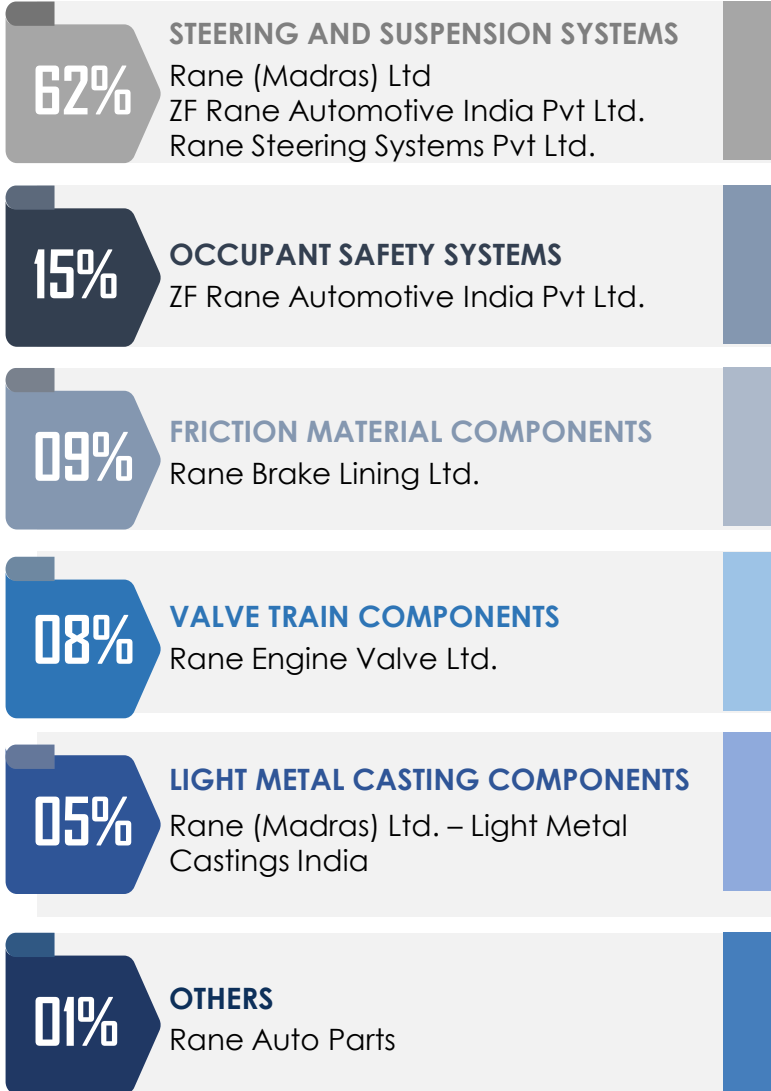

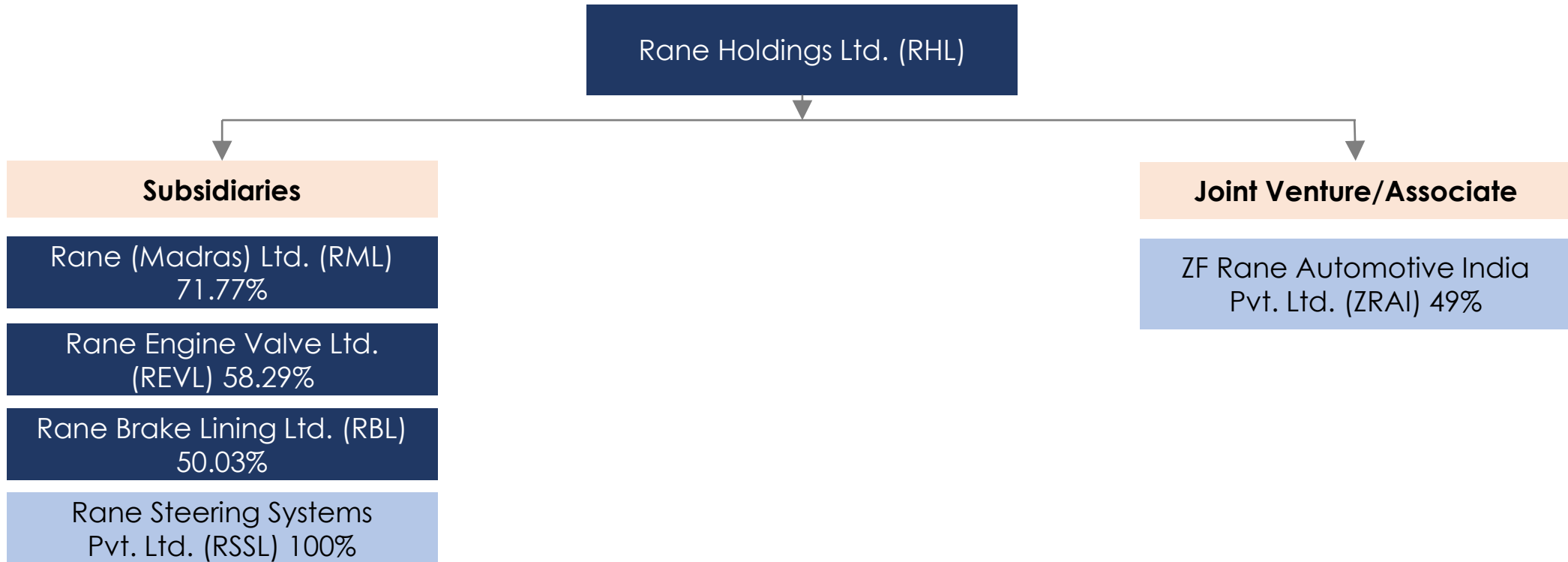

Listed

Share holding as on 31 December 2024

- Market leader in steering gear and steering linkage products in India. We have started catering to hydraulic products such as HSU and steering cylinders.
- Best in class manufacturing facilities at Chennai, Mysore, Puducherry and Pant Nagar.
- End to end testing facilities in house to validate the products' functional, endurance and environmental parameters.

## PRODUCTS

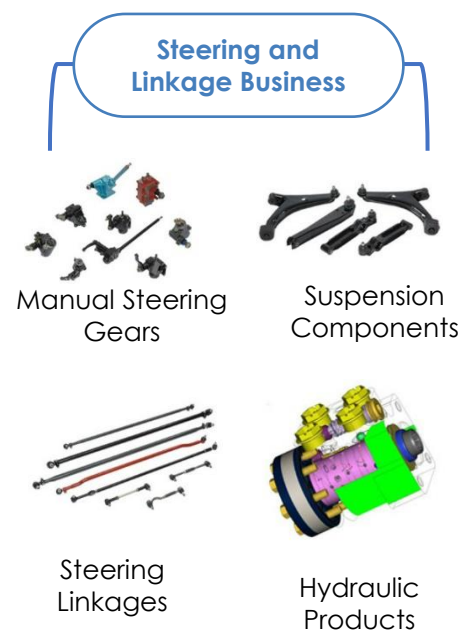

## MANUFACTURING PLANT

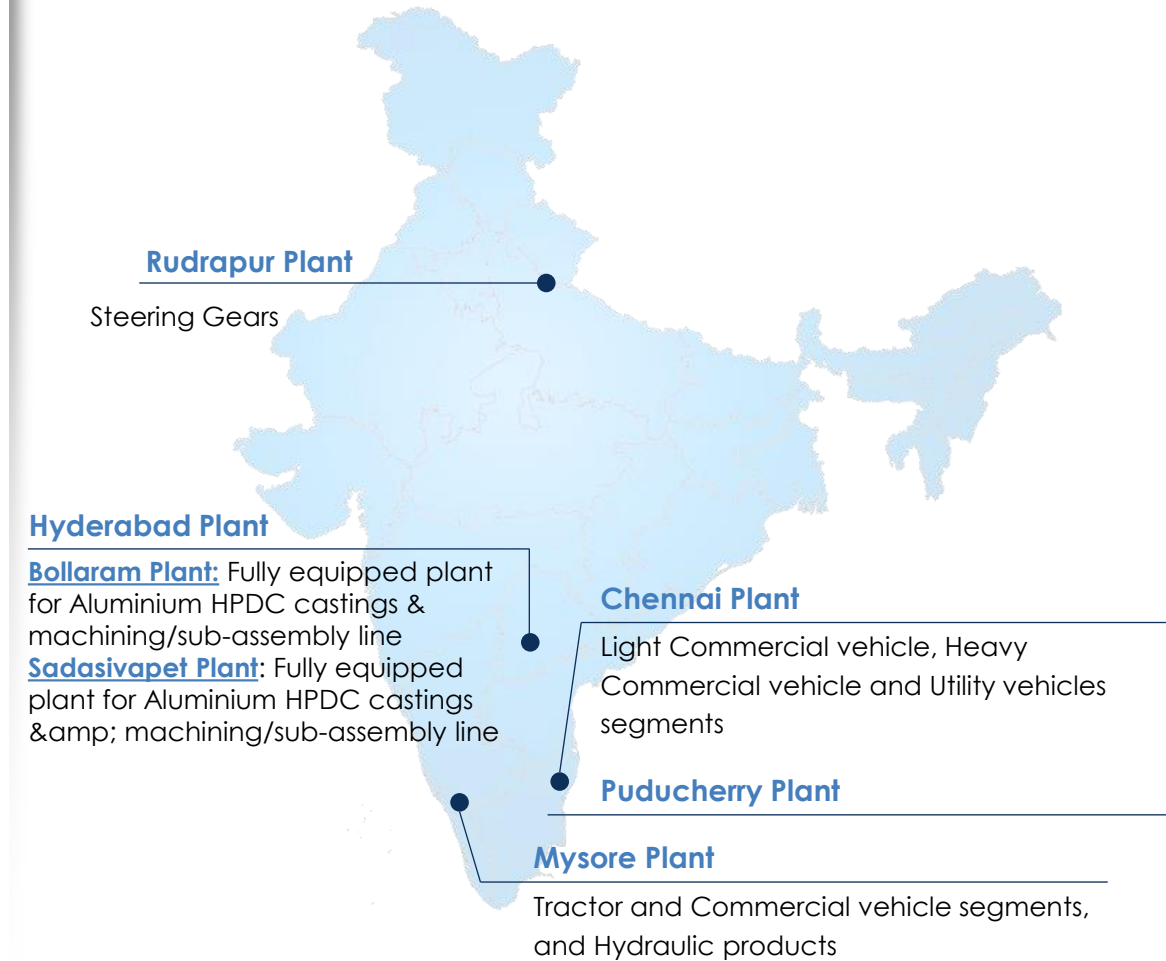

- Incepted In 1959, REVL manufactures valves and valve train components for various engine applications
- Non Automotive applications such as power generation, marine, defence, locomotive, etc.
- Comprehensive test laboratory for material characterisation, simulated test rigs and engine dynamometer test facility.

## PRODUCTS

Engine Valves



Valve Guides



Mechanical Tappets



## MANUFACTURING PLANT



### Hyderabad Plants (2)

Small Valves for 2W and PC  
Medium Valves for PC, Industrial and CV

### Tumakuru Plant

Medium Valves for CV and Farm Tractors  
Large & Extra Large Valves for Industrial, Power Generation and Marine Applications

### Chennai Plant

Small Valves for 2W and PC  
Medium Valves for Tractors and PC Guides, Tappets

### Trichy Plant

Small & medium Valves for 2W, PC and CV

- Established in 1964, RBL is a leader in Friction Products across OEM segments and supplies products to over 15 countries
- Technical collaboration with Nisshinbo Brakes Inc. and TMD Friction
- Library of widely tested and approved formulations to suit diverse market / customer requirements.
- State-of-the-art R&D center equipped with full scale inertia dynamometer, static mu-measurement and NVH study rig.

## PRODUCTS

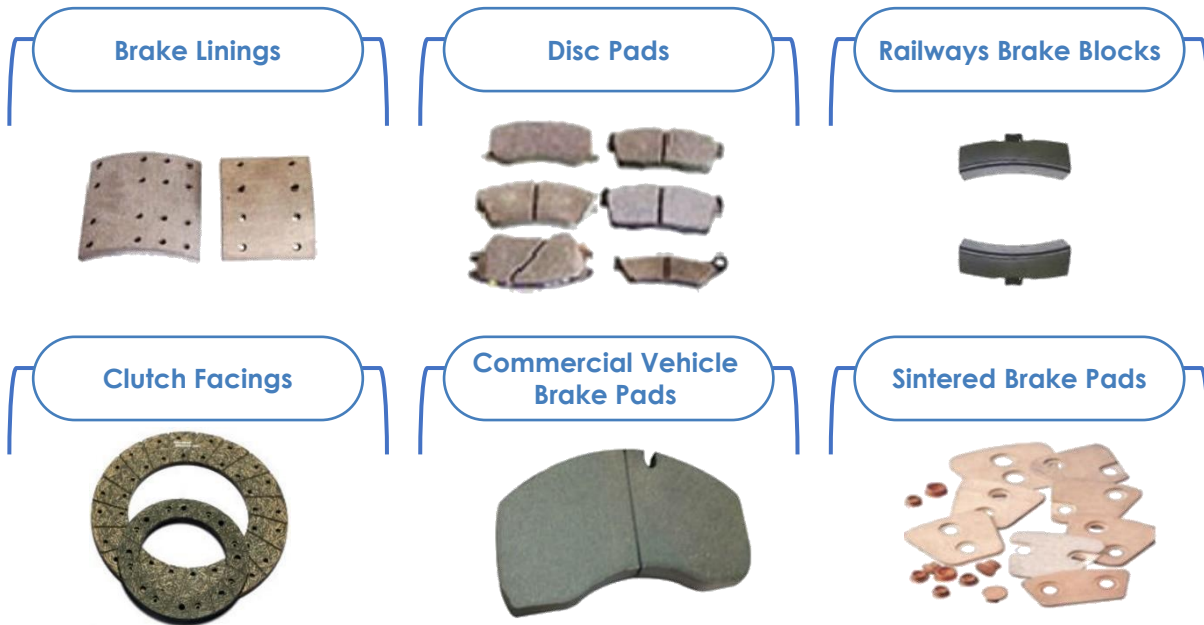

## MANUFACTURING PLANT

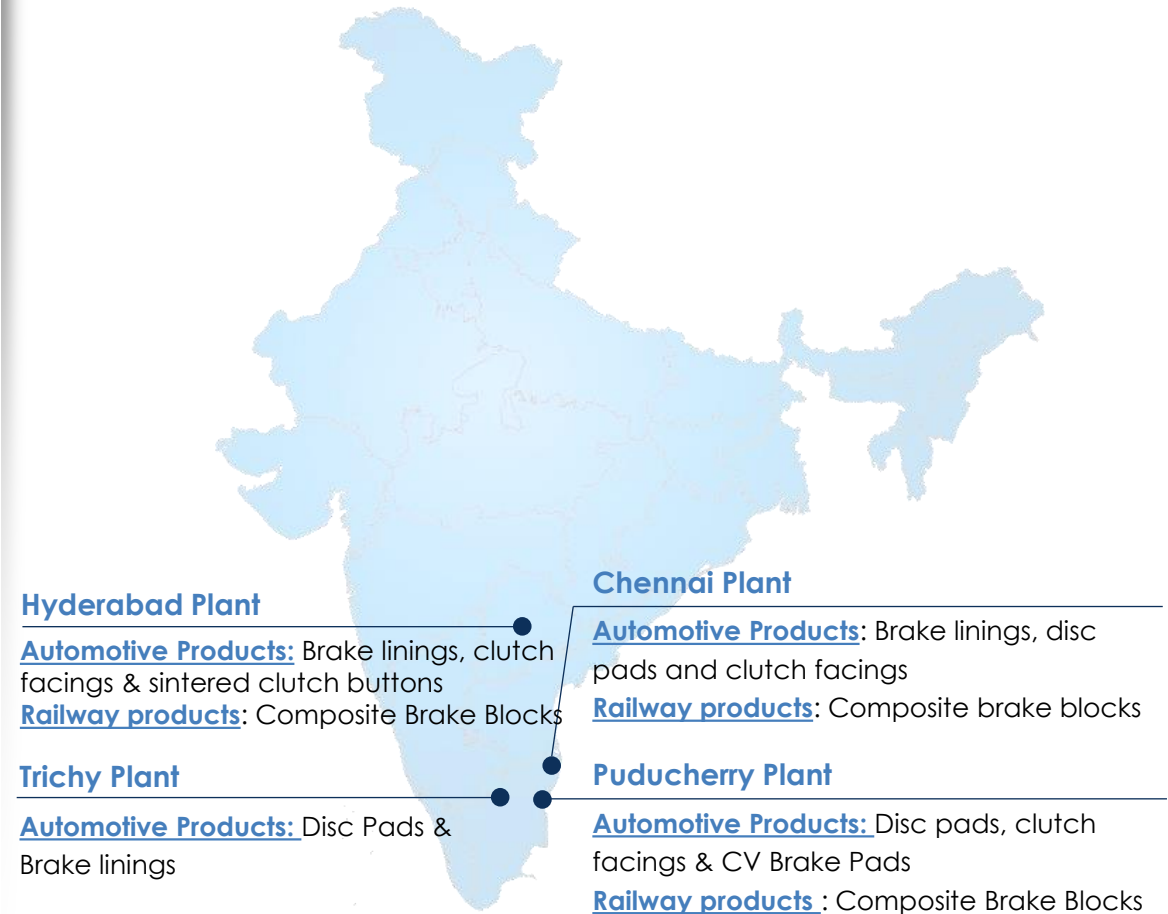



- State-of-art R&D test lab for validation of steering columns.
- Manufacturing facilities across four locations in Chennai, Bawal, Rudrapur & Ahmedabad.
- Design & Development capability for solid & energy absorbing columns. Development and application capability for EPS.
- Driver comfort, Passenger safety, Ergonomics and NVH requirements are kept as targets while designing steering system.
- Comprehensive test laboratory for extensive research about column performance characteristic validation, strength and durability validation and NVH requirements.
- Design team includes CAD & CAM application experts and software analysts.

## »»» PRODUCTS



## MANUFACTURING PLANT

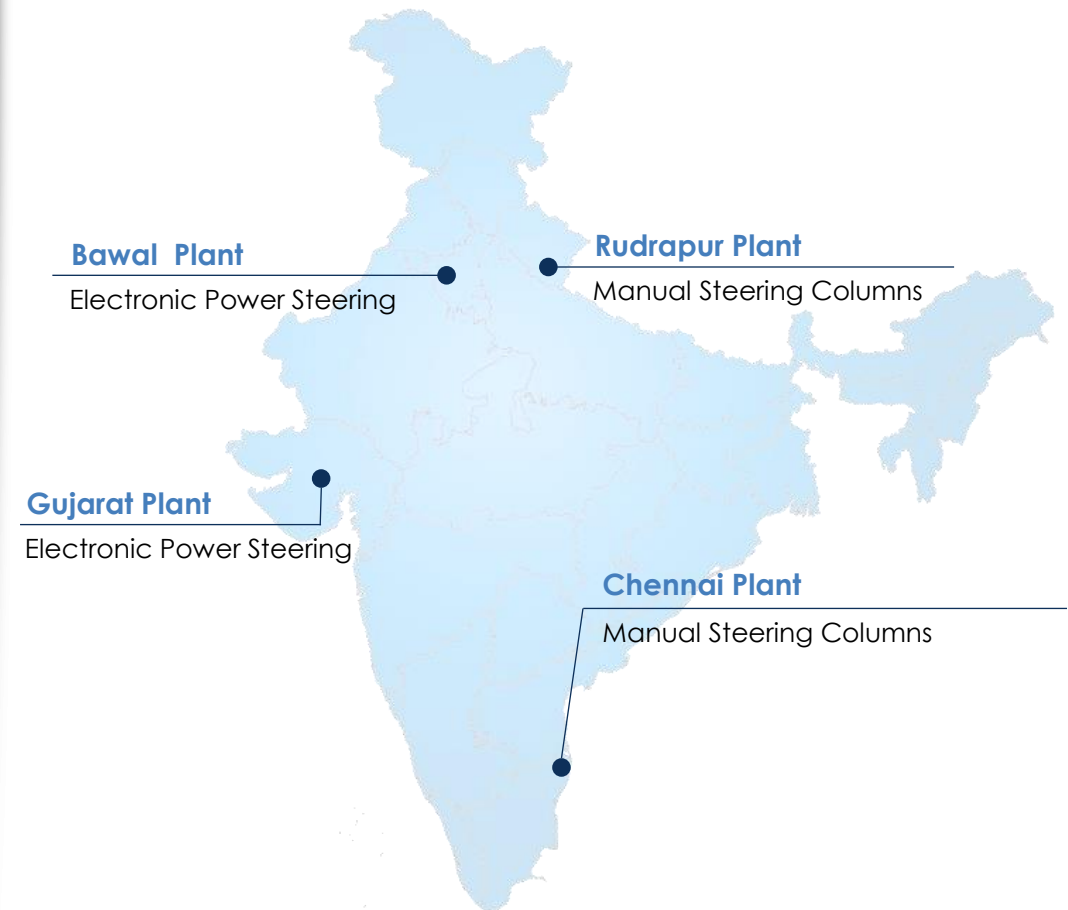

Joint venture partnership with ZF Group, Germany.

## Steering Gear Division

- Design, Development and Application capability for complete Hydraulic Power Steering system for all vehicles.
- Advanced design tools for 3D modeling, simulation, FE analysis and CFD.
- State-of-the-art testing facilities for strength, environment, noise, fatigue and durability tests to meet global standards

## Occupant Safety Division

- Product range includes different types of airbags, seatbelt technologies and steering wheels. Retractor and Anchor pretensioners, Emergency Locking Retractor (ELR), Load Limiters, Child Restraint Seat Belt, Driver Airbag, Passenger Airbag, Side Airbag and Curtain Airbags.
- Extensive testing facilities for seat belts include Extraction and Retraction Force Testing Machine, Retractor Durability Tester, Hot & Cold Chamber, Salt spray chamber, ELR functional tester.
- Equipped with Test lab to carry out testing as per National (IS/AIS), International (ECE/EEC/GS/VSCC), customer specifications and COP testing

## PRODUCTS

### Steering Gear Division



### Occupant Safety Division



## MANUFACTURING PLANT

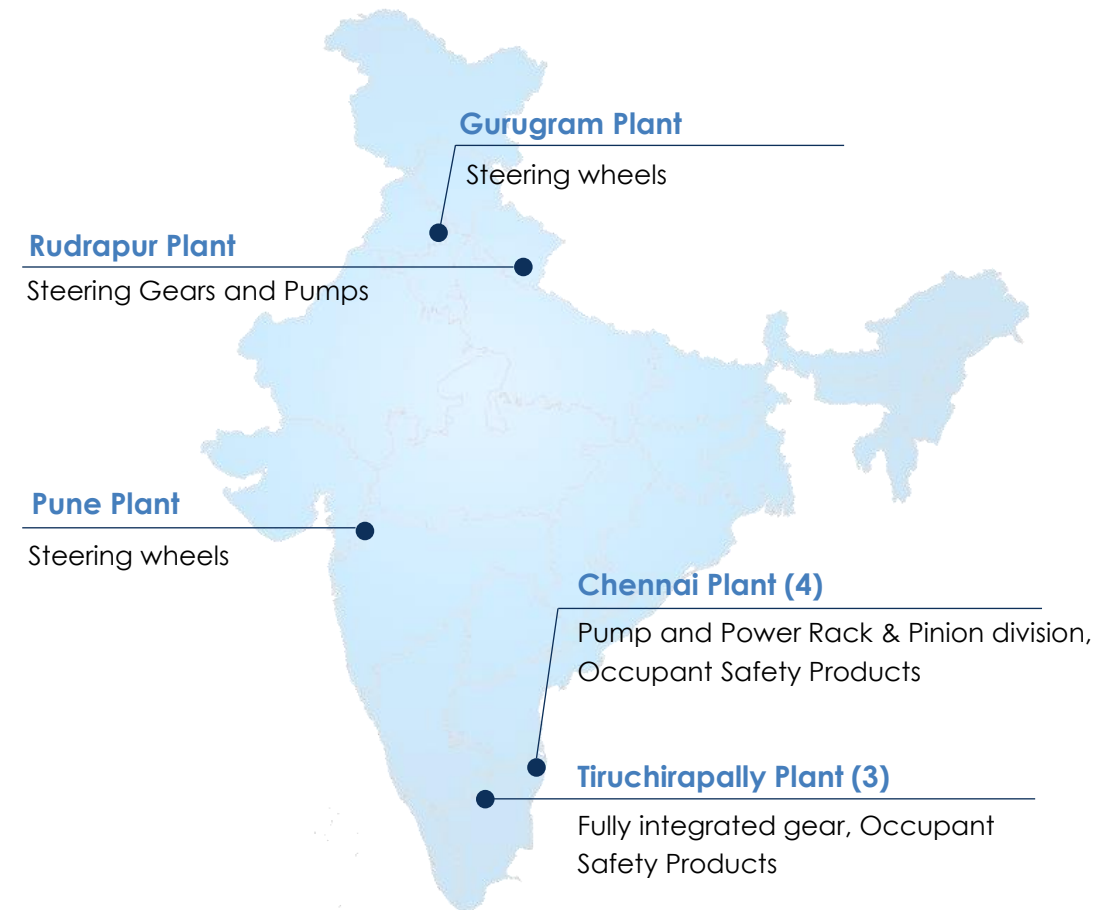

## Light Metal Casting Products

Pinion Housing

Engine Timing Case Cover

Outboard Housing

## Valve train Components

Engine Valves

## Occupant Safety Systems

Seat Belts

Airbags

## Friction Materials

Brake Lining

Disc Pad

Upper Control Arm

Stabilizer Link

Lower Control Arm

## Steering & Suspension Systems

Suspension Ball Joint

Outer Ball Joint

Inner Ball Joint

Power Steering Pump

Rack & Pinion steering gear  
-Mechanical  
-Hydraulic

Electric Power Steering Columns

### Rane (Madras)

- › Manual Steering Gears
- › Steering Linkages
- › Suspension Components
- › Light Metal Casting Products

### Rane Engine Valve

- › Engine Valves

### Rane Brake Lining

- › Brake Linings
- › Disc Pads

### Rane Steering Systems

- › Electric Power Steering Systems

### ZF Rane Automotive India

- › Hydraulic Power Steering systems
- › Seat Belts
- › Airbags

## Steering & Suspension Systems



Manual Steering Column



Power Steering Gear



Power Steering Pump



Manual RCB Steering Gear



Drag Link Assembly



Tie Rod Assembly

Hydraulic Cylinder (Twin/multi front axle trucks)



## Light Metal Casting Products

Hydraulic Pump Housing



## Occupant Safety Systems

Seat Belts



## Friction Materials

Brake Lining



Disc Pad



## Valve train Components

Valve Guides



Engine Valves

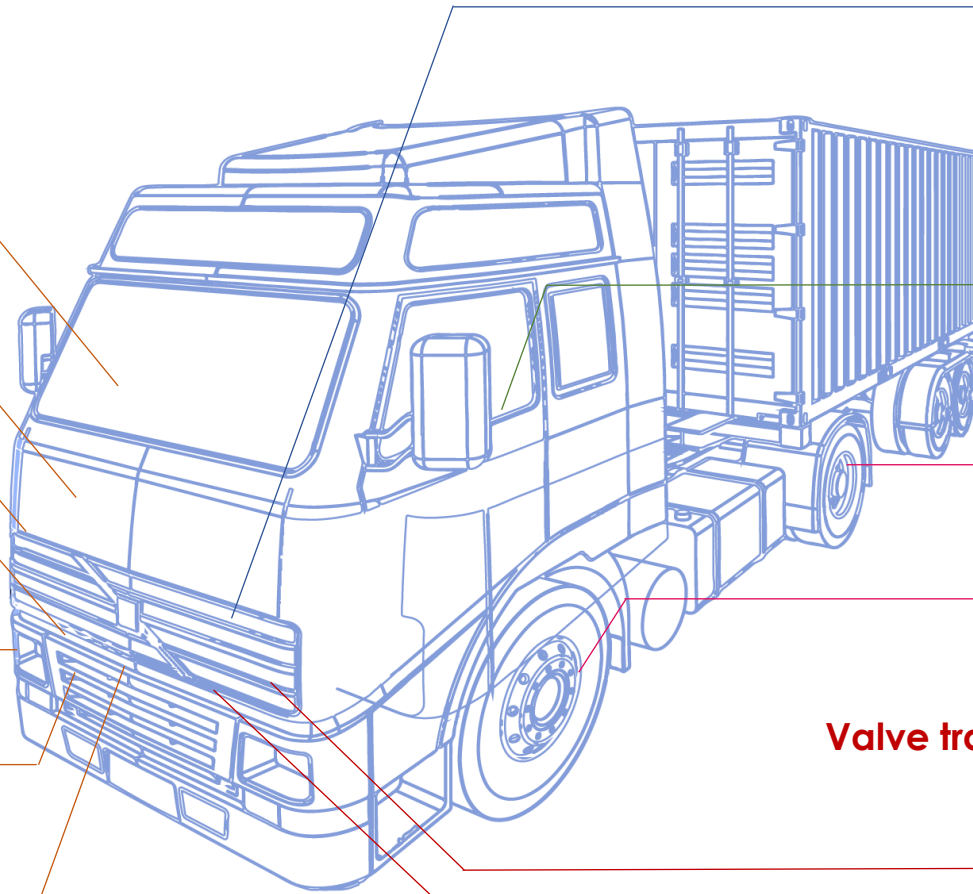

### Rane (Madras)

- › Manual Steering Gears
- › Steering Linkages
- › Hydraulic Cylinders
- › Light Metal Casting Products

### Rane Engine Valve

- › Engine Valves
- › Valve Guides

### Rane Brake Lining

- › Brake Linings
- › Brake Pads

### Rane Steering Systems

- › Manual Steering Column

### ZF Rane Automotive India

- › Hydraulic Power Steering Systems
- › Seat Belts

## Steering & Suspension Systems



Manual Steering /  
Column  
Manual RCB  
Steering Gear



Hydrostatic  
Steering Unit



Power Steering  
Gear



Drag Link Assembly



Tie Rod Assembly

Hydraulic  
Cylinder



## Friction Materials

Clutch Facings



Brake Lining

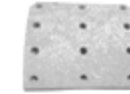

## Light Metal Casting Products

Timing Case Covers



Seat Belts



## Valve train components

Valve Guides



Engine Valves



### Rane (Madras)

- › Manual Steering Gears
- › Steering Linkages
- › Hydraulic Cylinders
- › Hydrostatic Steering Unit
- › Light Metal Casting Products

### Rane Engine Valve

- › Engine Valves
- › Valve Guides

### Rane Brake Lining

- › Brake Linings
- › Clutch Facings

### Rane Steering Systems

- › Manual Steering Column

### ZF Rane Automotive India

- › Hydraulic Power Steering systems
- › Seat Belts

## Friction Materials

Disc pad

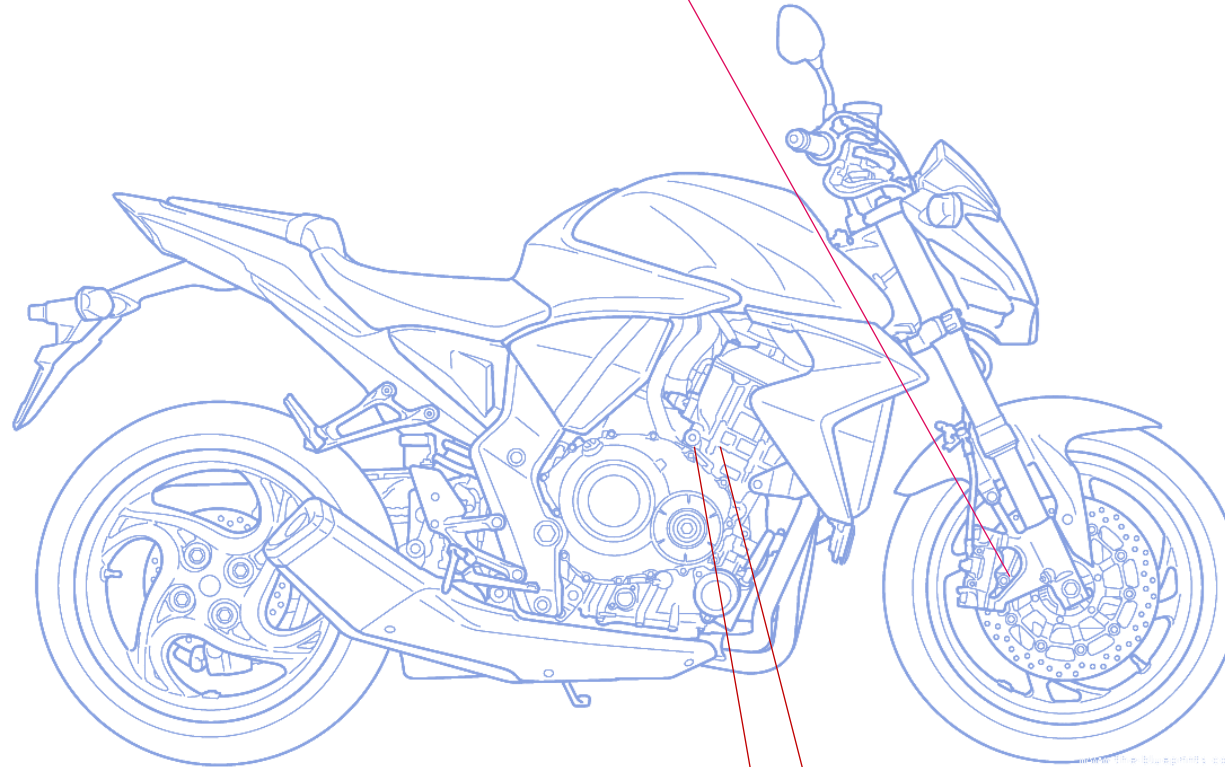

### Rane Brake Lining

- › Disc Pads

### Rane Engine Valve

- › Engine Valves
- › Valve Guides

## Valve train Components

Valve Guides



Engine Valves



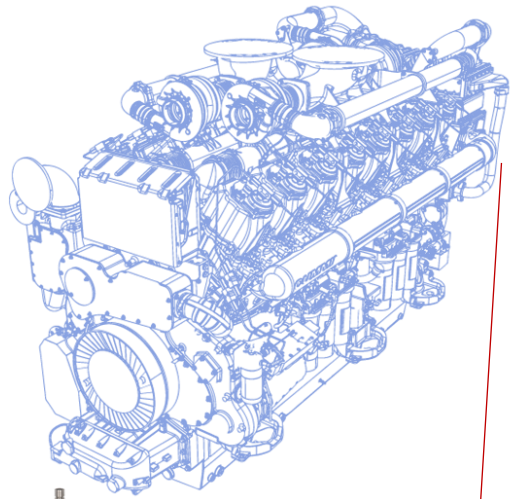

**Engine Valves / Valve Guides**

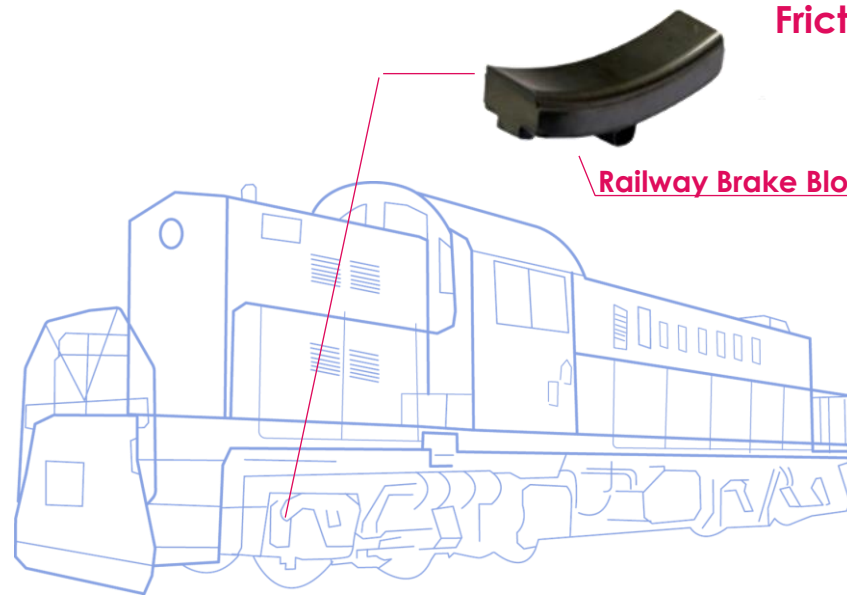
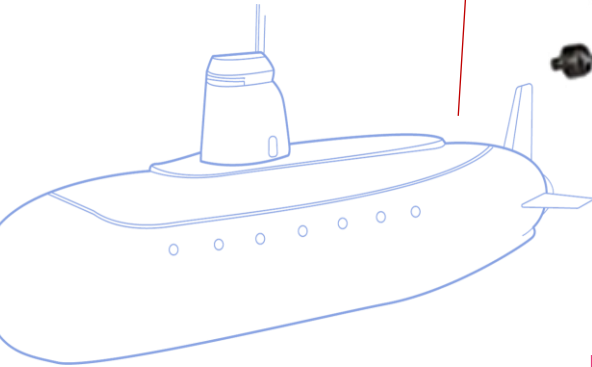

**Railway Brake Block**

**Friction Materials**



**Sintered Brake Pads**

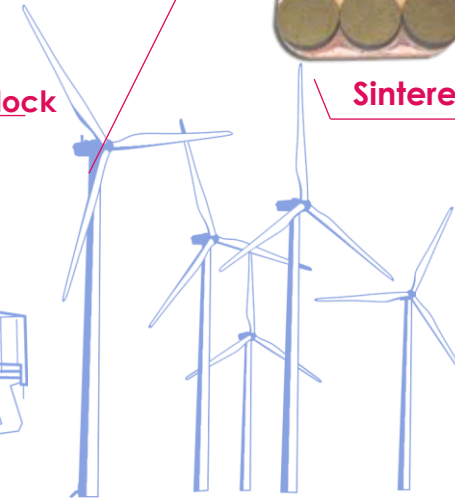

**Suspension Ball Joint  
Outer Ball Joint  
Inner Ball Joint**

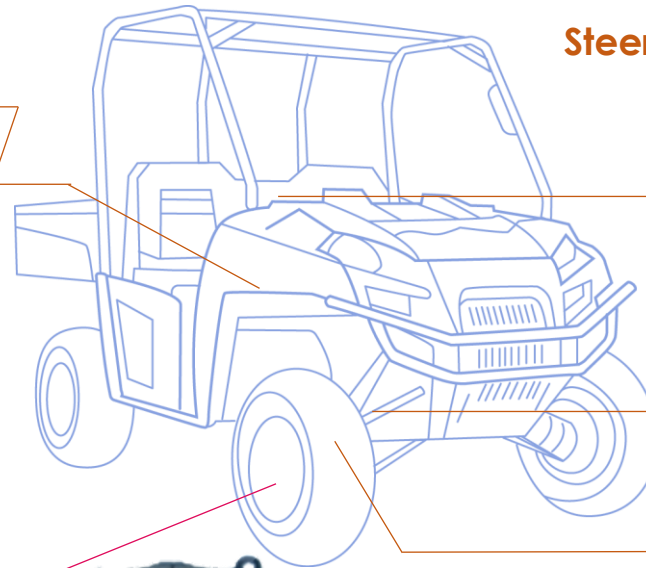

**Steering & Suspension Systems**



**Steering Shafts**



**Rack & Pinion steering gear - Mechanical**



**Stabilizer link**

**Friction Materials  
Disc pad**



**Rane (Madras)**

- › Manual Steering Gears
- › Steering Linkages
- › Light Metal Casting Products

**Rane Engine Valve**

- › Engine Valves
- › Valve Guides

**Rane Brake Lining**

- › Sintered Brake Pads
- › Railway Brake Block

**Rane Steering Systems**

- › Steering Shafts

## An illustrious journey of over 80 years from distributor of automobile and auto components to winner of Deming prize for manufacturing

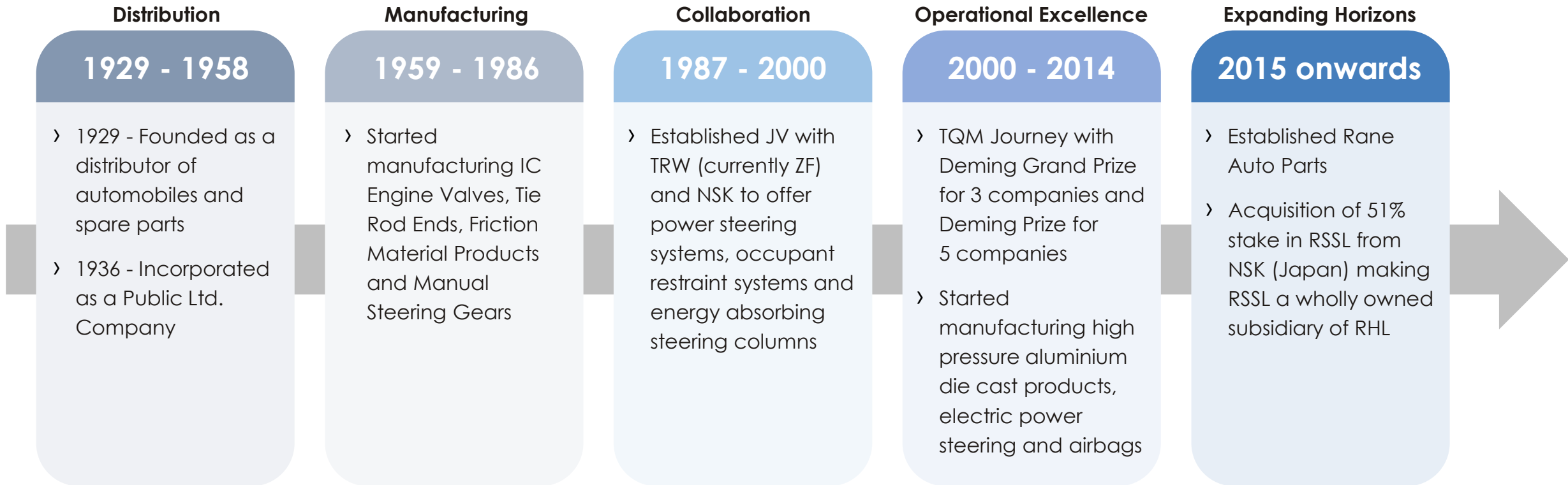





**30+** Serve customers in 30+ countries

**29** Manufacturing locations across India

Customer Locations   Manufacturing Locations   Sales Offices

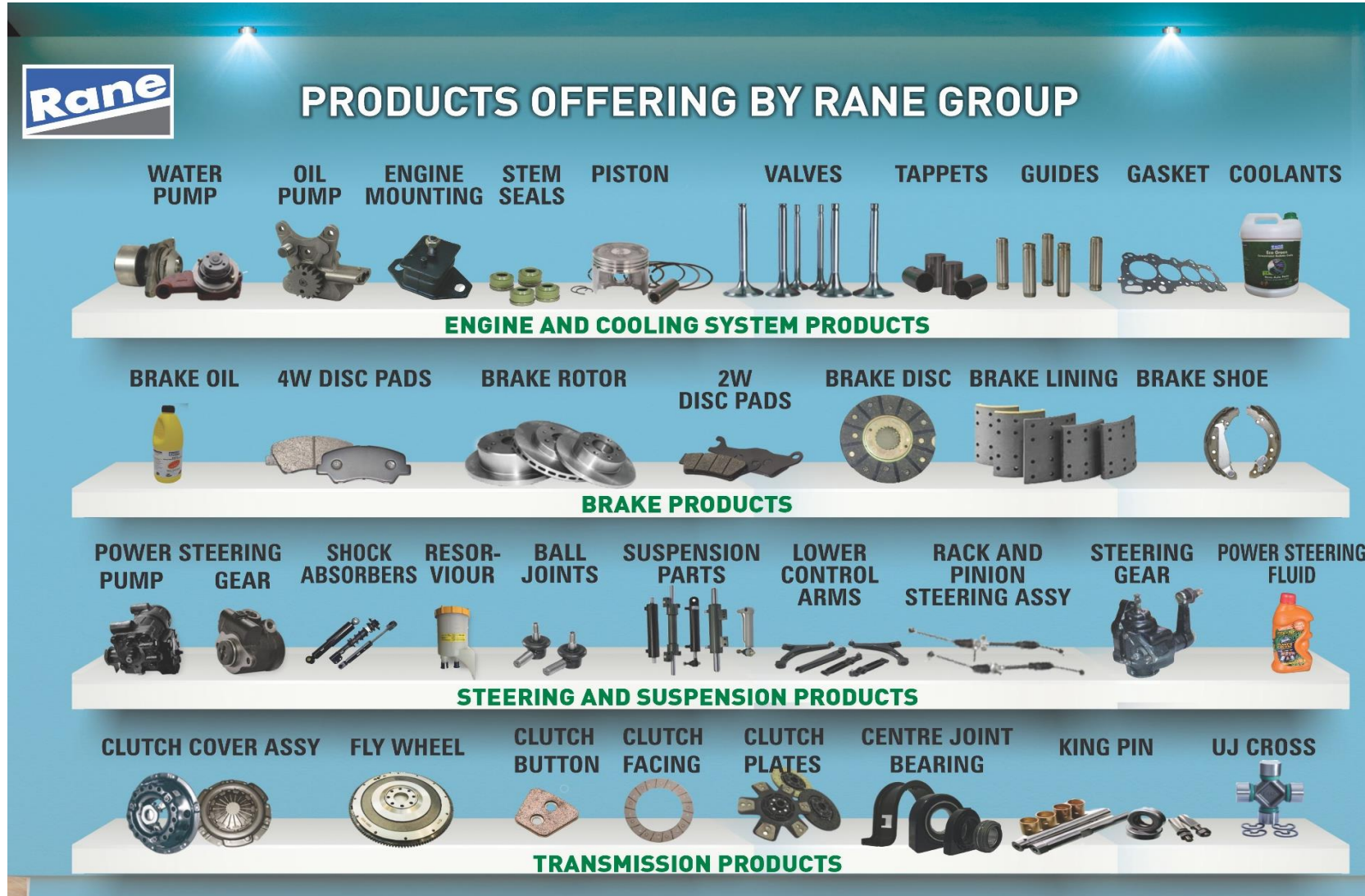

Increasing Group's brand presence in aftermarket through enhanced product portfolio and wider market reach

## Strong CAE Capabilities – Design, Analysis & Simulation Software

**230** R&D Engineers

**42** Functional Test Rigs

**26** Strength Test Rigs

**62** Durability Test Rigs

**33** Environmental Test Rigs

**10** Noise Test Rigs



Hydraulic Power Steering Systems and Occupant Safety Systems



Energy Absorbing Steering Columns and Electric Power Steering



Brake Linings, Discs Pads and Clutch Facings

We create and deliver value to our customers

Passenger Vehicle



Commercial Vehicle



Farm Tractor



Two/Three-Wheeler



Other Applications



INDIA

INTERNATIONAL

**'Customer at the core' remains our priority on the goal to sustainable growth and profitability**



## Rane Group

Customer	Award Category
<b>Mahindra &amp; Mahindra</b>	Business Partner of the year – Automotive Division
<b>Ki Mobility Solutions</b>	Partnership of Excellence



## Rane (Madras)

Customer	Award Category
<b>Volvo Eicher</b>	New Product Development Award
<b>Nexteer TAFE</b>	Perfect Quality Award Best Supplier & Benchmark Award
<b>Maruti Suzuki</b>	Superior Performance Award, Special Support
<b>SML Isuzu</b>	New Product Development Award
<b>Tata Motors</b>	Award for Exceptional Support, Best Supplier – Demand Fulfillment, Sustainability Excellence
<b>Toyota Industries</b>	Best Target Achieved Supplier Award
<b>Polaris</b>	Supplier of Excellence
<b>Daimler India</b>	Reliable Partner & Achieving 100% in delivery



## Rane Engine Valve

Customer	Award Category
<b>Groupe Renault</b>	Quality & Customer Satisfaction
<b>John Deere India</b>	Quality Appreciation Award
<b>Volvo Eicher</b>	Quality & Delivery excellence
<b>Renault Nissan</b>	Quality & Customer Satisfaction
<b>Hyundai</b>	Appreciation Award
<b>Cummins India</b>	Superior Quality Award



## ZF Rane

Customer	Award Category
<b>Ashok Leyland</b>	Best Performance in Business Alignment-Gold
<b>Isuzu Motors</b>	Most Improved Supplier Award
<b>Tata Motors</b>	Best Supplier Award, Efficiency Award, Best in Class Award
<b>Volvo Eicher</b>	Best Supplier in NPD, Supply Chain, Uptime Excellence
<b>Daimler India</b>	Quality Appreciation Award, Q Prime Supplier
<b>Renault Nissan</b>	Best Supplier in Field Quality



## Rane Brake Lining

Customer	Award Category
<b>Brakes India</b>	Best Supplier - Friction
<b>Ashok Leyland</b>	After Market Support Award
<b>Foundation Brake</b>	Business Excellence Award
<b>Endurance</b>	Gold Award for Quality Best Benchmark Award, Best Supplier Award, Consistent Vendor Rating Performance Award



## Rane Steering Systems

Customer	Award Category
<b>Maruti Suzuki</b>	Efforts in Vendor Import Localisation
<b>Honda Cars</b>	Award for best reduction in CO2
<b>Volvo Eicher</b>	Quality Excellence, Supply Chain Management
<b>Daimler India</b>	Best Technology Support

## Rane Values

- › Provide superior products and maintain market leadership
- › Pursue excellence
- › Achieve the highest standard of ethics and integrity

## Rane Approach

- › Build strong connections with customers to understand their challenges
- › Strategic investments to improve quality and productivity
- › TQM way of working
- › Emphasis on 'First-time right' policy

## Rane Credentials

- › Modern manufacturing facilities with IATF 16949 certification
- › State-of-the-art product development and validation capabilities
- › Deming Grand Prize for 3 Rane companies
- › Deming Prize for 5 Rane companies



- › Technology collaboration with top global players



ZF Group, Germany  
Hydraulic Power Steering Systems and Occupant Safety Systems



NSK, Japan  
Energy Absorbing Steering Columns and Electric Power Steering



Nisshinbo Brake Inc., Japan  
Brake Linings, Disc Pads and Clutch Facings

## Value Proposition

- › Superior products driven by execution excellence
- › Trusted partner with shorter development lead times
- › Agile manufacturing process and scalable facilities
- › Provide system-level solutions with deep understanding of customer needs
- › With enhanced R&D capabilities, we provide light-weighting, improved safety and performance

**LONG TERM PARTNER OF CHOICE TO LEADING  
AUTOMOTIVE COMPANIES AND TIER 1 SUPPLIERS**

An exciting workplace founded on the principles of values, fairness and transparency that:



Provides challenging assignments

Encourages learning

Enhances career opportunities



- › **Organisation Development Excellence Award** for the exceptional practices on **Leadership Development** by Transcendence, Tata Institute of Social Sciences (TISS), 2019
- › Recognized by International Federation of Training and Development Organizations in Best HRD practice category, 2018
- › Award for **Talent Management** from the Employer Branding institute, Singapore, 2012 & 2014
- › Significant Achievement in **HR Excellence**, CII, 2012



Certified as a **Great Workplace** by the Great Place to Work institute, 2024



## Systems approach to deliver H&S to our employees

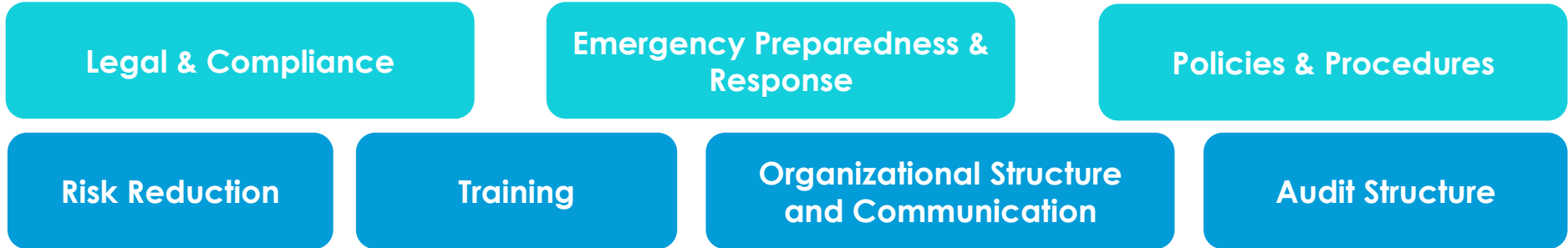

We create value through sustainable operations and optimal resource utilization

## Dimensions of Sustainability at Rane Group

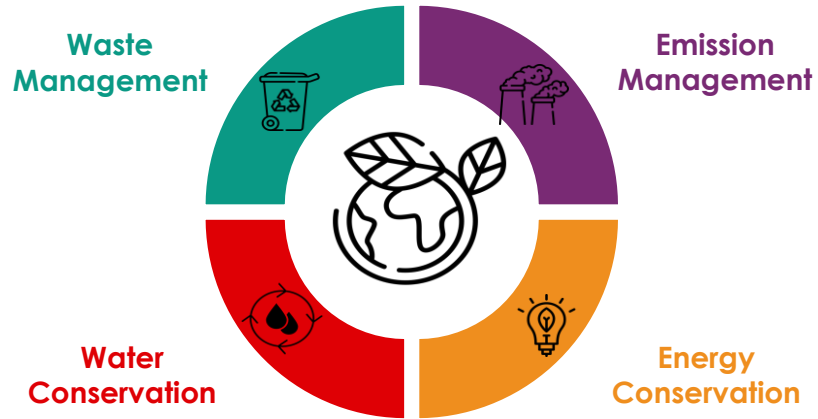

## Recognition in Sustainability Excellence

- Rane Brake Lining - Puducherry won the CII National Award for Excellence in Energy Management
- Rane Brake Lining - Trichy received second prize for Environment Protection and Management by the Government of Tamil Nadu
- Rane Steering Systems – Chennai won the CII National Award for Excellence in Energy Management
- Various facilities are certified by US green building council
- Rane (Madras) – Varanavasi received 'GreenCo Gold' certification

## Water Conservation

Water Positive is achieved through Rain Water Harvesting and Water Conservation Techniques



## Energy Conservation



**58.5 lakhs units**  
of power saved on  
annualised basis in FY24



**4,211 MT Tons**  
Reduction of Eq. Co2 emission

## Transitioning to renewable energy



**36% of power demand**  
met by Renewable Energy

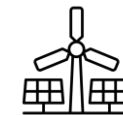

**Reduction of 45,233 MT  
of Eq. Co2** savings compared  
to power from traditional sources



- › Rane Foundation (RF) is a **public charitable trust** founded by Rane's promoters in the year 1967
- › RF is the **main arm for Rane's Corporate Social Responsibility (CSR) initiatives** and is exclusively funded by the Rane companies
- › Initiatives are focused on **education, healthcare, environment and community development**

## Rane Polytechnic



### Education

- › Institution Development - Rane Polytechnic, Rane Vidyalaya
- › Vocational Training & Skill Development
- › Awareness programs



### Healthcare

- › Nutrition program
- › Health camps
- › Medical infrastructure & aid



### Environment

- › Plantation drives
- › Infrastructure for sustainability
- › Natural resource preservation



### Community Development

- › Providing amenities & sanitation
- › Improving quality of life
- › Rural infrastructure development program

## Rane Vidyalaya



# Thank You

For further information, please contact:

[investorservices@ranegroup.com](mailto:investorservices@ranegroup.com) or [diwakar.pingle@in.ey.com](mailto:diwakar.pingle@in.ey.com)

## **Rane Corporate Centre**

"Maithri" 132, Cathedral Road,  
Chennai - 600 086, India  
[www.ranegroup.com](http://www.ranegroup.com)

## Glossary of Abbreviations

Abbreviation	Expansion	Abbreviation	Expansion
ACMA	Automotive Component Manufacturers Association	OEM	Original Equipment Manufacturer
AMP	Advanced Machining Processes	OES	Original Equipment Supplier
ATV	All Terrain Vehicle	OSD	Occupancy Safety Division
bps	Basis point, 100 bps equal to 1%	PC	Passenger Car
CII	Confederation of Indian Industry	PV	Passenger vehicle
Cr	Crores	QC	Quality Control
CV	Commercial Vehicle	R&D	Research and development
ELR	Emergency Locking Retractor	RBL	Rane Brake Lining Limited
EPS	Earnings per share / Electronic power steering	REVL	Rane Engine Valve Limited
EV	Electric vehicle	RHL	Rane Holdings Limited
FT	Farm Tractors	RML	Rane (Madras) Limited
FY	Financial Year	RSSL	Rane Steering Systems Pvt Limited
HPDC	High Pressure Die Casting	SUV	Sport Utility vehicle
HR	Human Resource	SE	Station Engine
Intl	International	SGD	Steering Gear Division
JV	Joint Venture	TPM	Total Productive Maintenance
LCV	Light Commercial Vehicles	TQM	Total Quality Management
LMCA	Light Metal Casting Inc., America	US	United States
Ltd	Limited	USD	United States Dollar
M&HCV	Medium & Heavy Commercial Vehicles	YoY	Year-on-Year
MUV	Multi Utility Vehicle	ZRAI	ZF Rane Automotive India Pvt limited
NPD	New Product Development	2W/3W/4W	Two Wheeler/Three Wheeler/Four Wheeler
OE	Original Equipment		

*This presentation may contain certain forward looking statements concerning Rane's future business prospects and business profitability, which are subject to a number of risks and uncertainties and the actual results could materially differ from those in such forward looking statements. The risks and uncertainties relating to these statements include, but not limited to risks and uncertainties regarding fluctuations in earnings, our ability to manage growth, competition (both domestic and international), economic growth in India and the target countries for exports, ability to attract and retain highly skilled professionals, government policies and action with respect to investments, fiscal deficits, regulations etc., interest and other fiscal costs generally prevailing in the economy. The company does not undertake to make any announcement in case any of these forward looking statement become materially incorrect in future or update any forward looking statements made from time to time by or on behalf of the Company.*